

farming snails 1

learning about snails
building a pen
food and shelter plants



BETTER FARMING SERIES

The titles published in this series were designed as handbooks for an intermediate-level agricultural education and training course. They may be purchased as a set or as individual documents. New titles will be added from time to time.

1. The plant: the living plant; the root
2. The plant: the stem; the buds; the leaves
3. The plant: the flower
4. The soil: how the soil is made up
5. The soil: how to conserve the soil
6. The soil: how to improve the soil
7. Crop farming
8. Animal husbandry: feeding and care of animals
9. Animal husbandry: animal diseases; how animals reproduce
10. The farm business survey
11. Cattle breeding
12. Sheep and goat breeding
13. Keeping chickens
14. Farming with animal power
15. Cereals
16. Roots and tubers
17. Groundnuts
18. Bananas
19. Market gardening
20. Upland rice
21. Wet paddy or swamp rice
22. Cocoa
23. Coffee
24. The oil palm
25. The rubber tree
26. The modern farm business
27. Freshwater fish-farming: how to begin
28. Water: where water comes from
29. Better freshwater fish-farming: the pond
30. Better freshwater fish-farming: the fish
31. Biogas: what it is; how it is made; how to use it
32. Biogas 2: building a better biogas unit
33. Farming snails 1: learning about snails; building a pen; food and shelter plants
34. Farming snails 2: choosing snails; care and harvesting; further improvement

farming snails 1

learning about snails
building a pen
food and shelter plants

P-69

ISBN 92-5-102396-4

PREFACE

The first twenty-six volumes in FAO's Better Farming Series were based on the **Cours d'apprentissage agricole** prepared in Côte d'Ivoire by the **Institut africain de développement économique et social** for use by extension workers. Later volumes, beginning with No. 27, have been prepared by FAO for use in agricultural development at the farm and family level. The approach has deliberately been a general one, the intention being to constitute basic prototype outlines to be modified or expanded in each area according to local conditions of agriculture.

Many of the booklets deal with specific crops and techniques, while others are intended to give the farmer more general information which can help him to understand **why** he does what he does, so that he will be able to do it better. Booklets No. 33 and 34 were added to the series owing to a growing interest in small-scale snail farming for food and profit in many countries where FAO's Better Farming Series is widely used.

Adaptations of the series, or of individual volumes in it, have been published in Amharic, Arabic, Bengali, Creole, Hindi, Igala, Indonesian, Kiswahili, Malagasy, SiSwati, Thai and Turkish.

Requests for permission to issue this manual in other languages and to adapt it according to local climatic and ecological conditions are welcomed. They should be addressed to the Director, Publications Division, Food and Agriculture Organization of the United Nations, Via delle Terme di Caracalla, 00100 Rome, Italy.

OUTLINE OF THE BOOKLET

● Introduction	1
What do you need to start?	3
● Learning about snails	5
What kind of snails can you farm?	6
Where can you get snails?	12
Where can you farm snails?	14
The soil and the water in the soil	14
Plants for food and plants for shelter	18
Dew and rain	21
Land that is wet	22
Wind	23
Where do you keep snails when you farm them?	24
How many snails will you need when you first begin?	26
How much snail meat can you expect to get?	27
Now you must decide	28
● How to begin	29
Choose a place on your land to put your snail farm	29
Clean the site and prepare the ground ...	31
● Building a pen	36
● Plant the food and shelter plants	47
When are the plants big enough for food and for shelter?	56

INTRODUCTION

1. Did you know that many kinds of snails are good to eat?
2. Snail meat tastes good and it is also good for you. If you have snail meat to eat, it will help to keep you and your family strong and healthy.

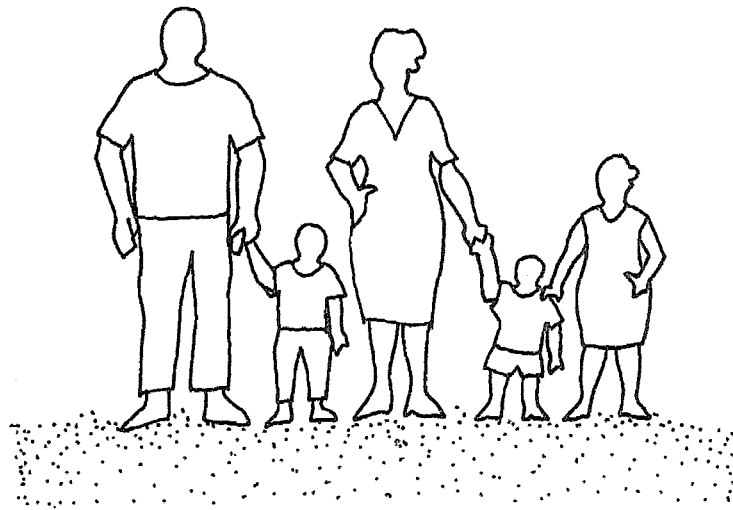

3. If you want to have snails to eat you can get them in different ways.
4. Many people gather wild snails that live nearby. Sometimes you can buy snails at the market or from people who gather them to sell to others.
5. You can also raise your own snails. This is called **snail farming**. Today, a great many people all over the world farm snails.

6. If **you** farm your own snails, you will always have a supply of fresh snail meat whenever you want it.
7. Then, if your family is **not too big** and you grow more snails than you need to eat, you can sell what you do not use to your neighbours or at the market.



8. With more food to eat and the money you get by selling snails, you and your family can live better.
9. However, if your family is **big** you will need to grow many more snails if you are going to have enough to eat **and** to sell at the market.

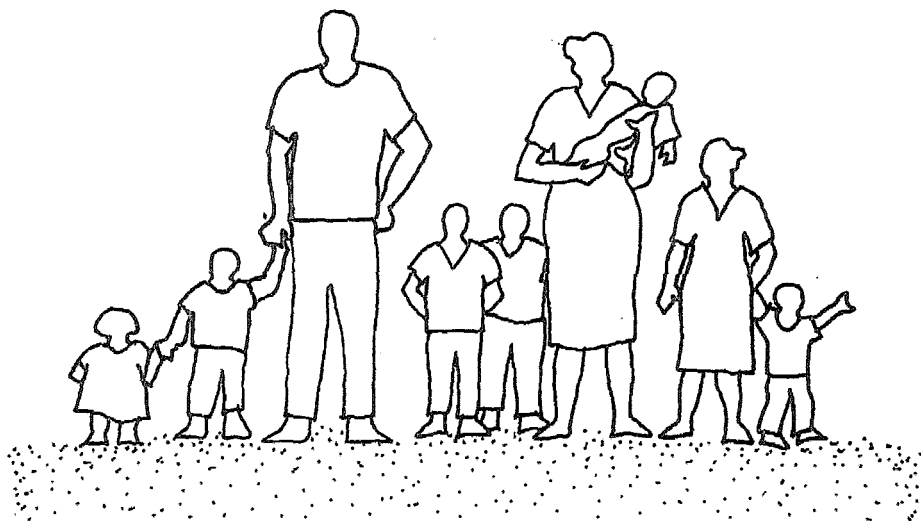

What do you need to start?

You will need

- enough snails to start your snail farm

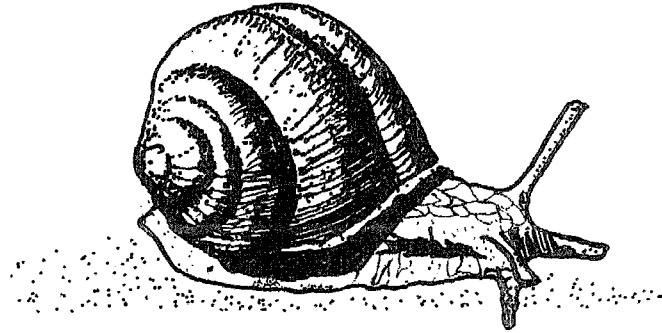

- a place near your house with the right kind of soil and the right amount of water for snails to live and grow

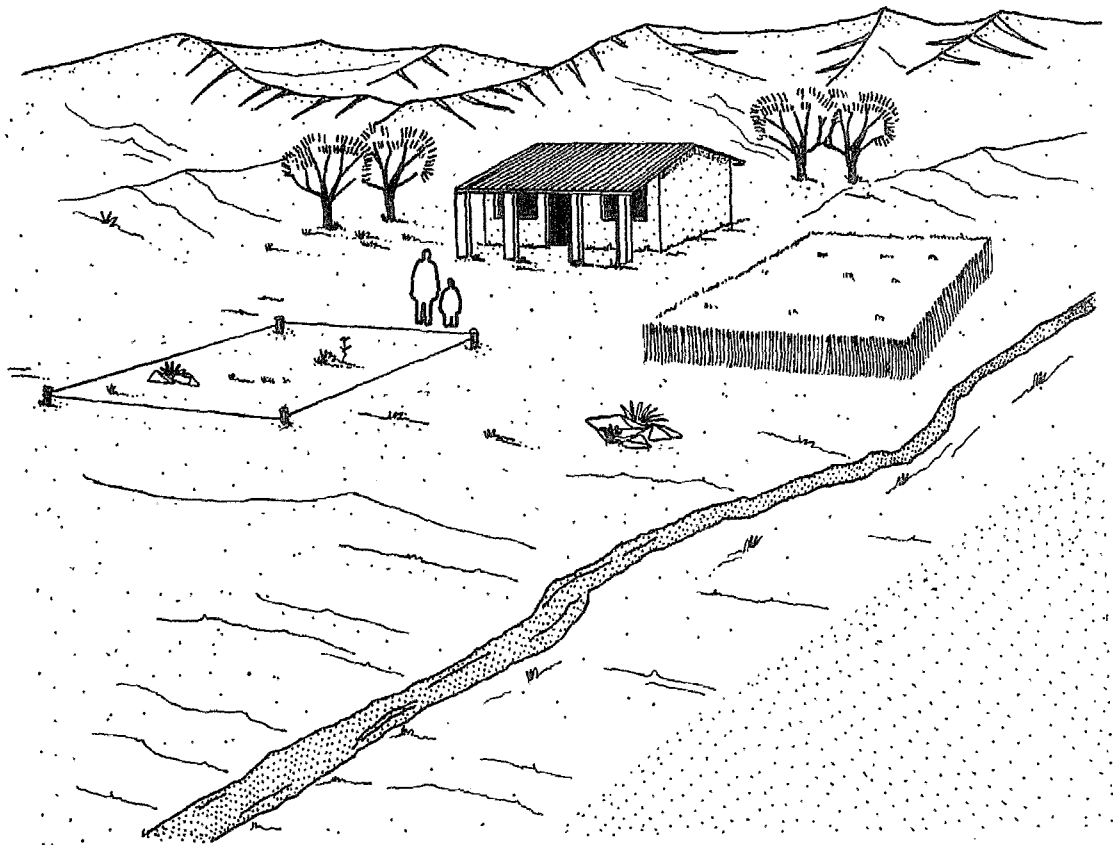

- the kinds of plants that snails need for food and shelter



- the materials to build a pen for the snail

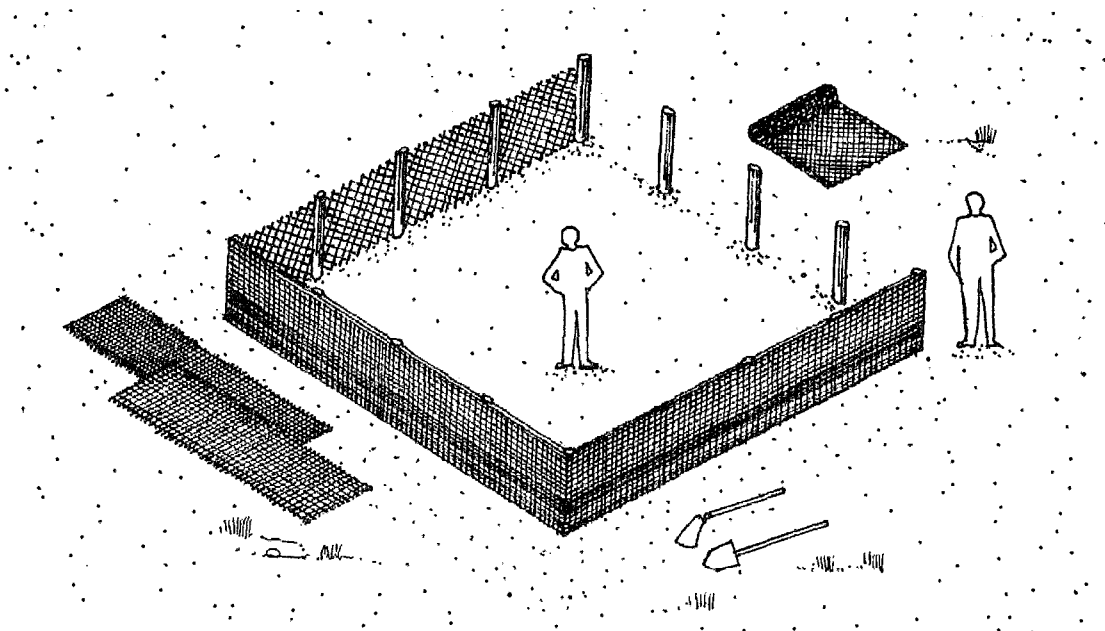

10. If you have or can get all of these things, you can raise snails.

LEARNING ABOUT SNAILS

11. To farm snails is not hard; however, it is quite different from keeping chickens or ducks or from growing crops such as maize, rice, cassava or groundnuts.
12. Since farming snails is so different from other kinds of farming, you will have to learn a lot of new things.
13. One way to learn about snails so that you will be able to farm them is to watch the wild snails that live near you.



14. Try to see how they live,
how they move and where they go,
what plants they like best
and what they eat.
15. You can learn many things
by watching wild snails
that will help you later
if you decide to start a snail farm.

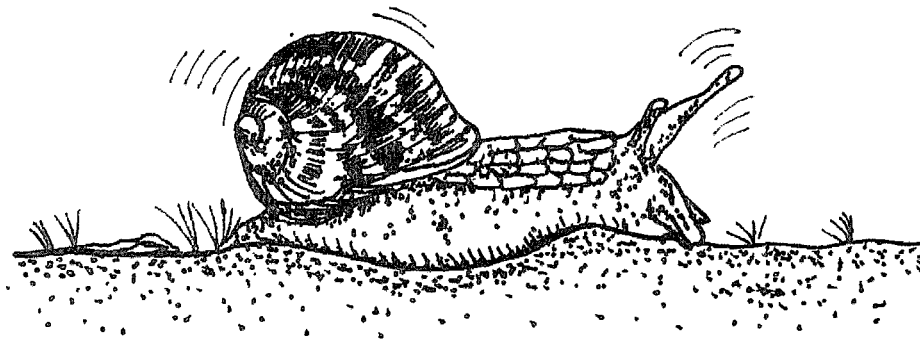

16. Another way to learn about snails
is to ask an older farmer
who knows a lot about your area.
If there are people near you
who gather snails to sell to others,
they may be able to help you.
17. In the next part of this booklet,
you will begin to learn
some things that you need to know
to farm snails.

What kind of snails can you farm?

18. The kind of snails that you can farm
are snails that live on land,
and there are many kinds of land snails
that are **good** to eat.
19. However, some kinds of land snails
are **not good** to eat
and they may even make you
very, very sick.

20. So, you must be very careful when you choose snails to farm. **If you are not sure that a snail is good to eat, do not use it.**

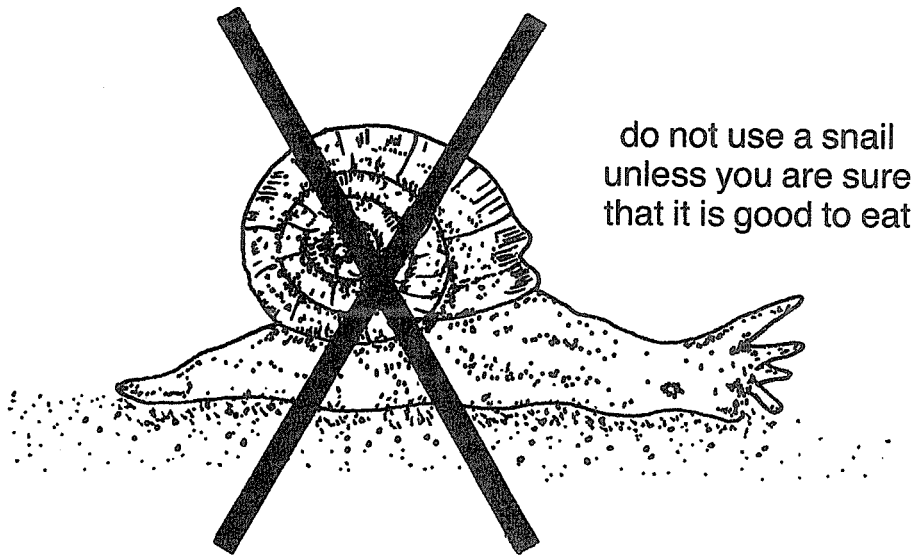

21. Now look at the drawings on pages 8 to 11 and you will see four kinds of good snails that live in different places.
22. You may be able to find one of these kinds of snails where you live. Notice that two of them are small and two of them are large.
23. The smaller kinds of snails, shown on pages 8 and 9, can often be found in places where part of the year is warm and part of the year is cold.
24. The larger kinds of snails, shown on pages 10 and 11, can often be found in places where it is warm all year round.

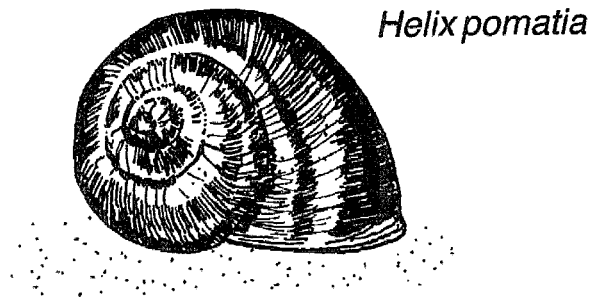

Helix pomatia

This kind of small snail

- 1 can be found in places where part of the year is warm and part of the year is cold
- 2 weighs from 15 to 25 grams and measures from 40 to 50 millimetres
- 3 has a strong shell which is pale brown and off-white
- 4 grows to full size in two to three years if it is well fed
- 5 lays from 30 to 50 eggs each growing season

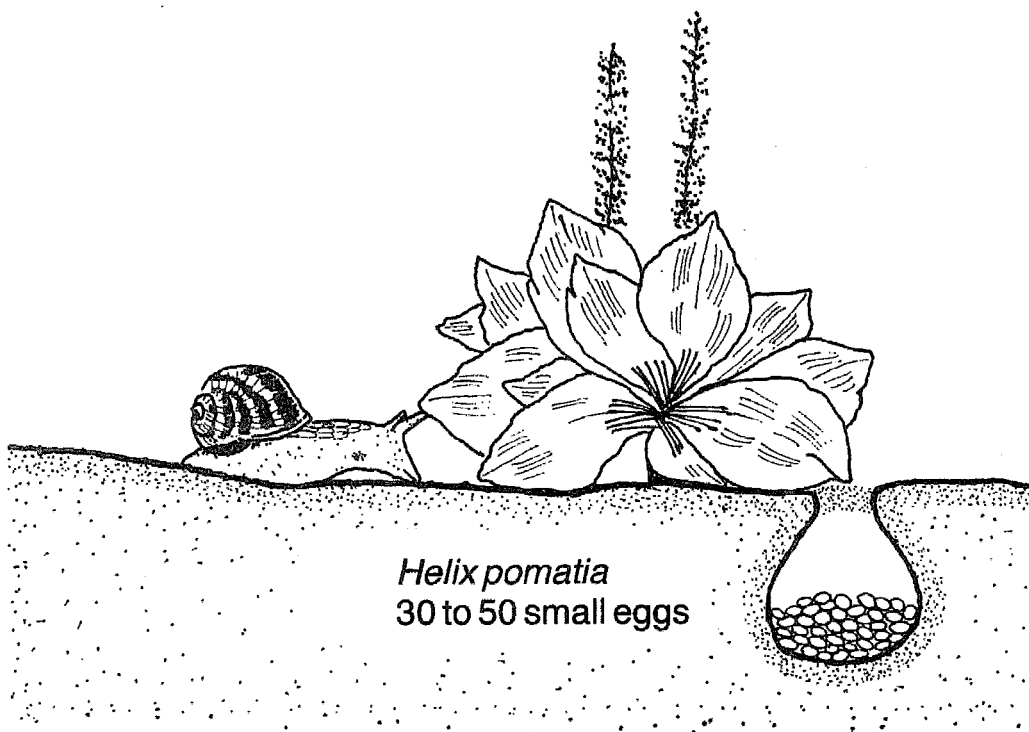

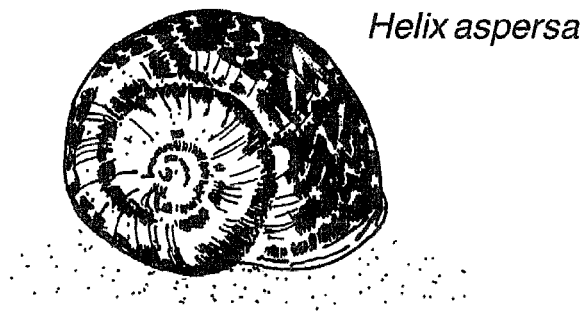

This kind of small snail

- 1 can often be found in places where part of the year is warm and part of the year is cold
- 2 weighs from 4 to 20 grams and measures from 30 to 45 millimetres
- 3 has a weak shell with broken stripes which are light brown to black
- 4 grows to full size in one year if it is well fed
- 5 lays from 40 to 170 eggs one to three times each growing season

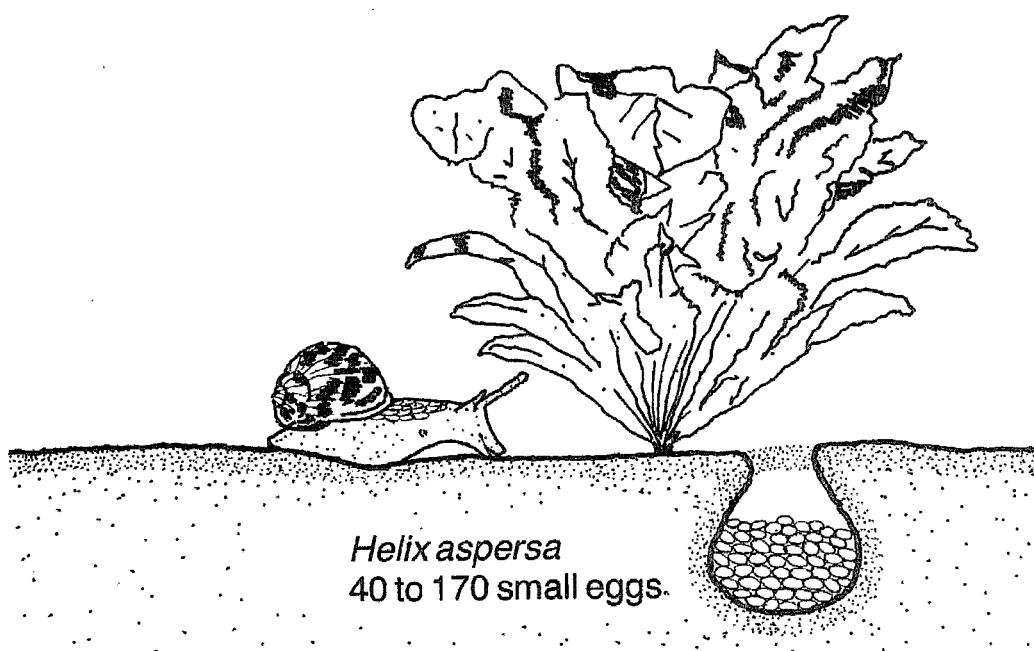

Achatina achatina

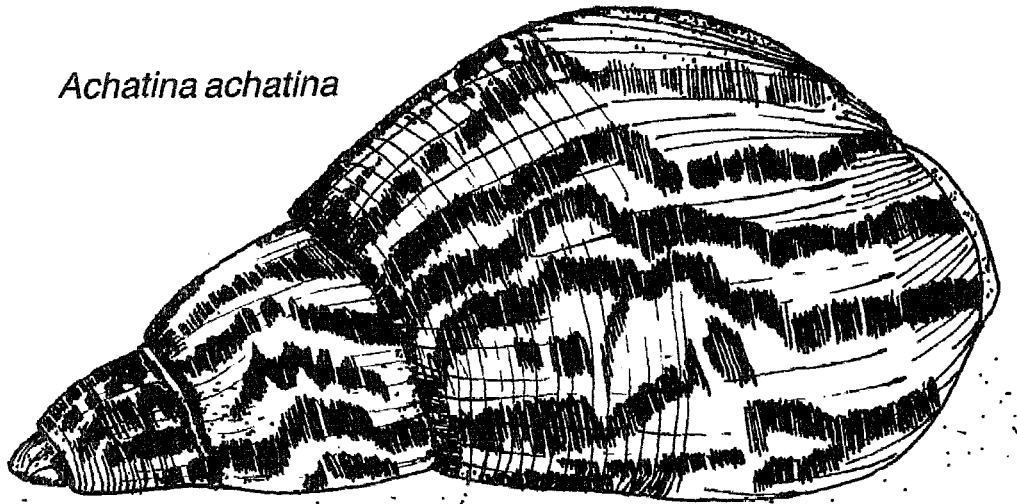

This kind of large snail

- 1 can often be found in places where it is warm all year round
- 2 weighs from 150 to 200 grams or more and measures from 90 to 130 millimetres
- 3 has a very strong brown shell
- 4 grows to full size in two years if it is well fed
- 5 lays from 100 to 300 eggs one to two times each growing season

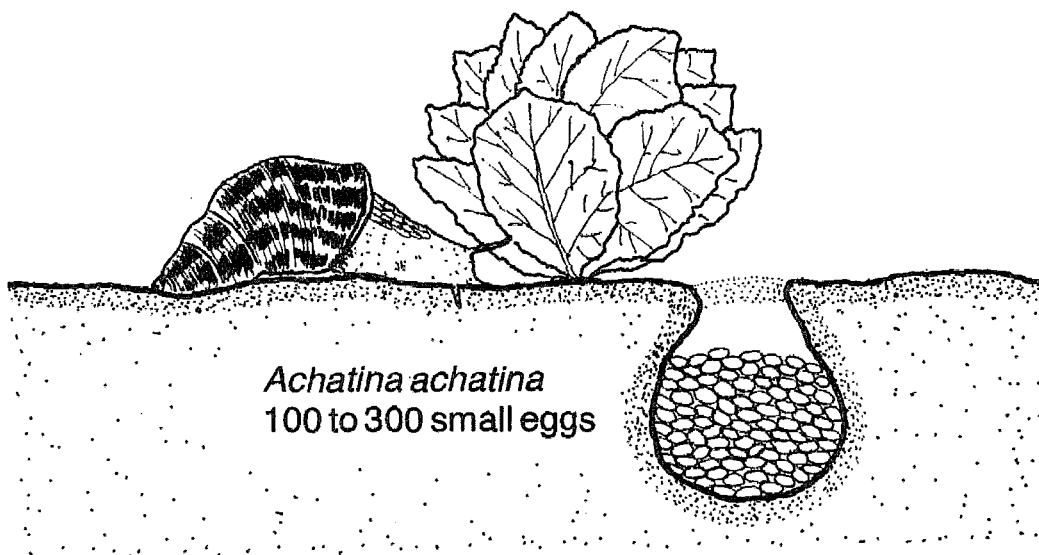

Archachatina marginata

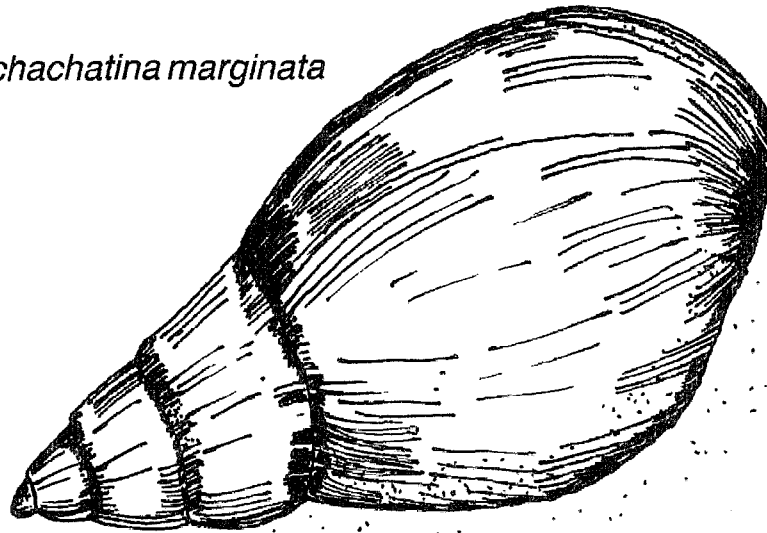

This kind of large snail

- 1 can often be found in places where it is warm all year round
- 2 weighs from 150 to 200 grams or more and measures from 90 to 130 millimetres
- 3 has a very strong brown shell
- 4 grows to full size in two years if it is well fed
- 5 lays from five to ten eggs four to eight times each growing season

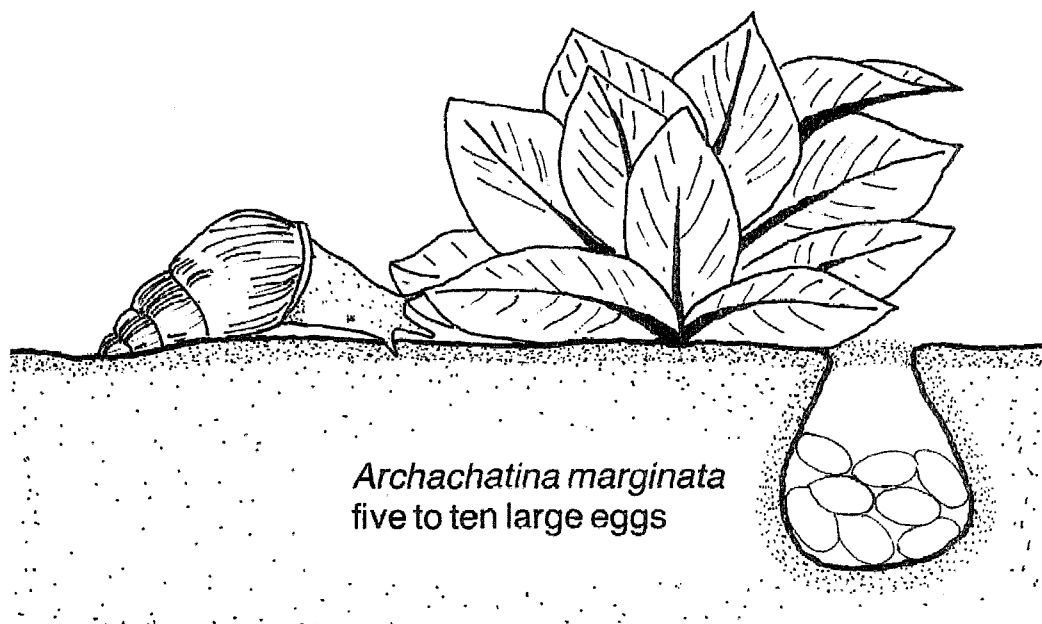

25. If you cannot get one of these snails, you may be able to get others very much like them where you live.
26. There are **many** other kinds of good snails. There may even be several kinds of good snails that are eaten where you live.
27. If snails are eaten where you live, you can farm one of these. Then you will be sure that it is good to eat.

Where can you get snails?

28. When you are ready to get snails, perhaps you can get them by gathering wild snails that live near you.



29. Perhaps you can buy them from people who gather wild snails to sell to others.

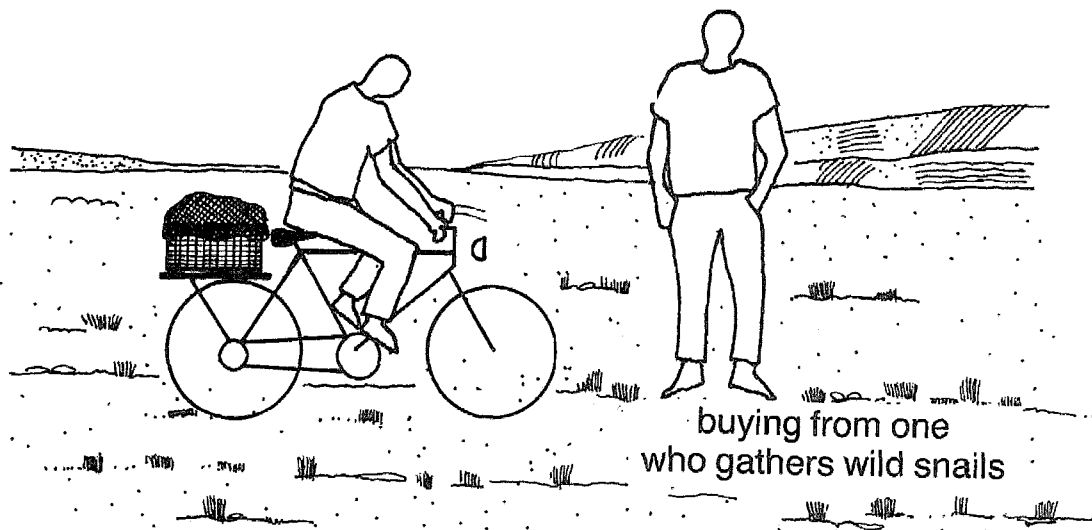

30. You may even be able to buy them from another snail farmer.

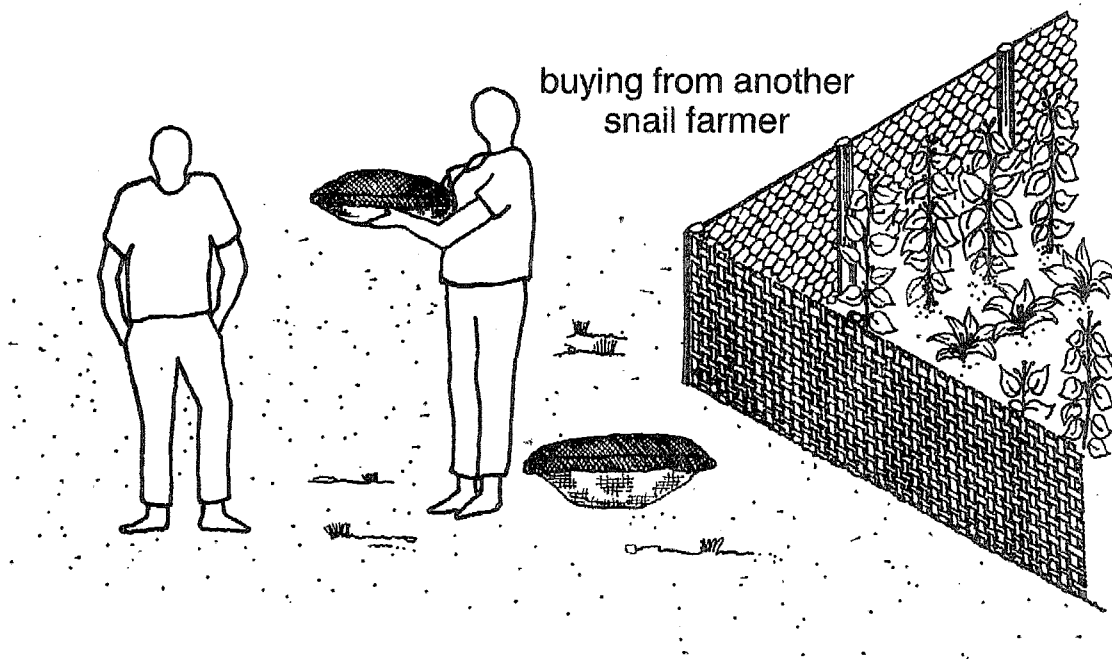

Note

Never farm snails that you buy at the market. Snails at the market may have been washed, kept too cold or hurt and they may die soon.

Where can you farm snails?

31. A good place for a snail farm is one where there already are snails. If there already are snails, you will know that the soil and the water in the soil are right for snails to live and grow.
32. However, if there are no snails near where you live it does **not** mean that you cannot raise snails there.
33. If you have the right kind of soil with the right amount of water, you can bring good snails from another place to start your snail farm.

The soil and the water in the soil

34. Soil is important for snails. Part of the time they live on the soil and part of the time they live in the soil, and to live well, snails need good soil.

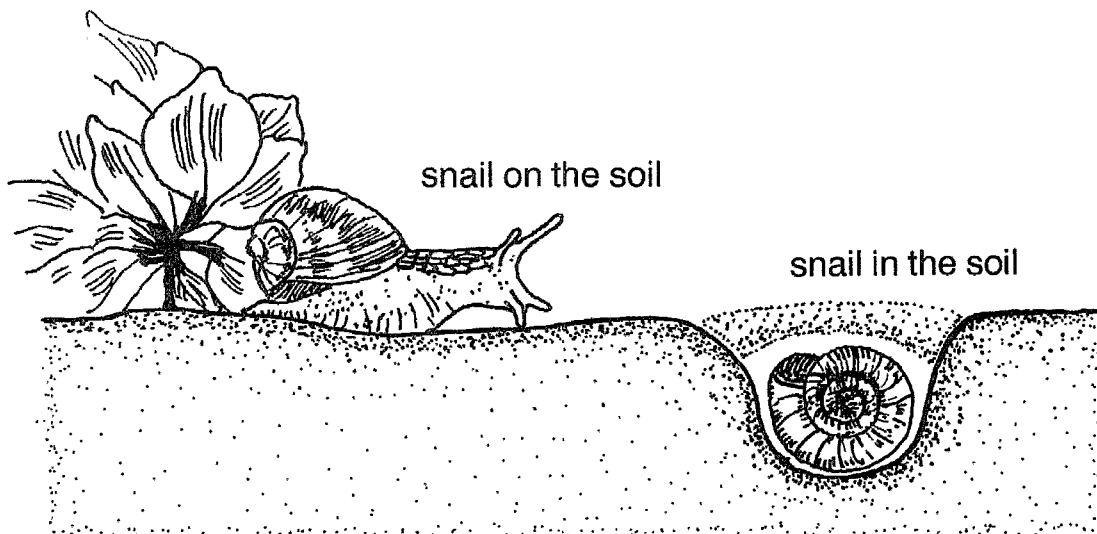

35. When snails are not on the soil or in the soil, they are on plants which grow in the soil. So, the soil must also be good for the kinds of plants that snails need.

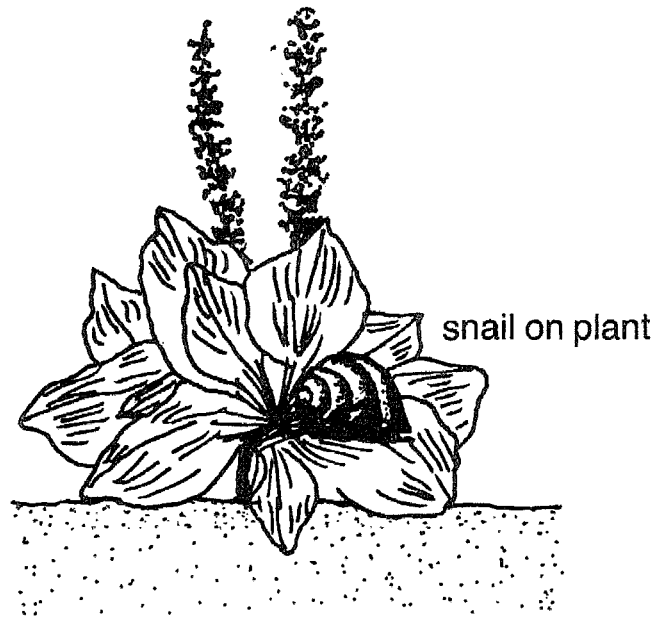

36. When snails are in the soil; they are resting or laying their eggs. If the soil has the right amount of water, snails will live well, the eggs they lay will hatch well and the baby snails will come out of the soil easily.
37. Snails cannot live in hard soil such as heavy clay soils. When heavy clay soil is too dry, snails cannot dig into it to rest and lay their eggs. When heavy clay is too wet, snails and the eggs they lay may die.
38. Snails cannot live in loose soil such as soils that have a lot of sand. Sandy soils do not hold enough water for snail eggs to hatch.

39. The drawings on the next page show how a snail digs a hole, lays its eggs, closes the hole and how the baby snails come out when they have hatched.
40. Snails need **calcium** from the soil to make their shells. All snails grow better and have stronger shells when there is a lot of calcium in the soil.
41. So, if you are going to farm snails, you **must** have a good medium soil that has neither too much clay nor too much sand. It must also have enough calcium and the right amount of water for your snails to live and grow.

Note

**If you have a garden,
you can easily tell
if your soil is good for snails.
If your green leafy vegetables grow well,
snails will also grow well
in the same kind of soil.**



1 snail digging a hole

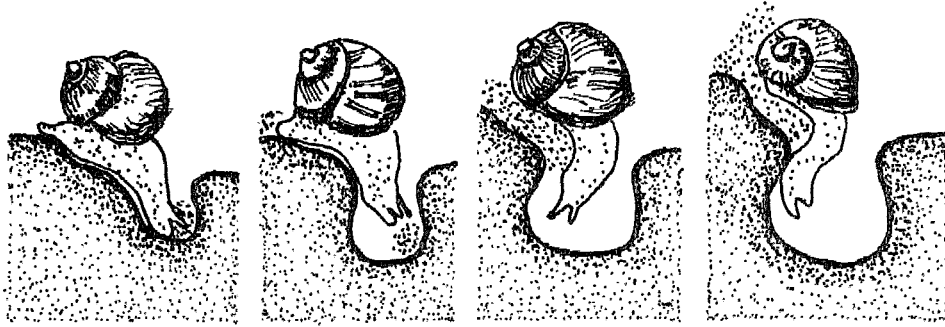

2 laying the eggs
and closing the hole

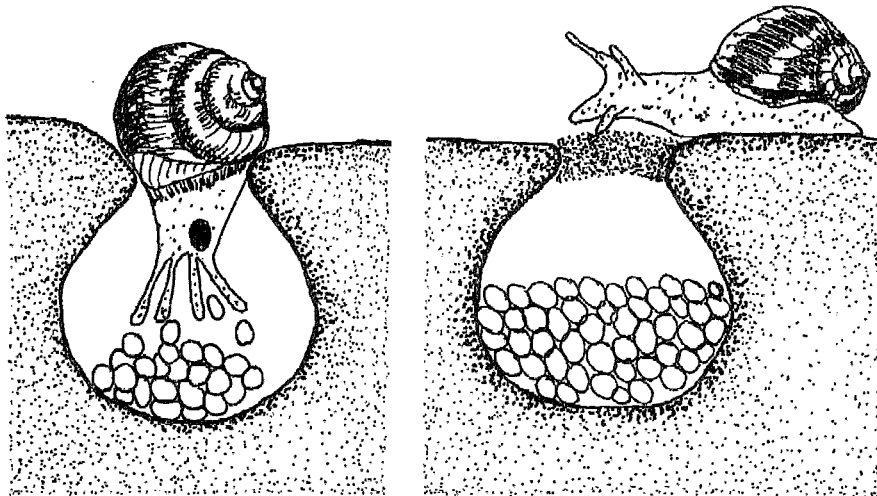

3 baby snails hatching
and coming out of the hole

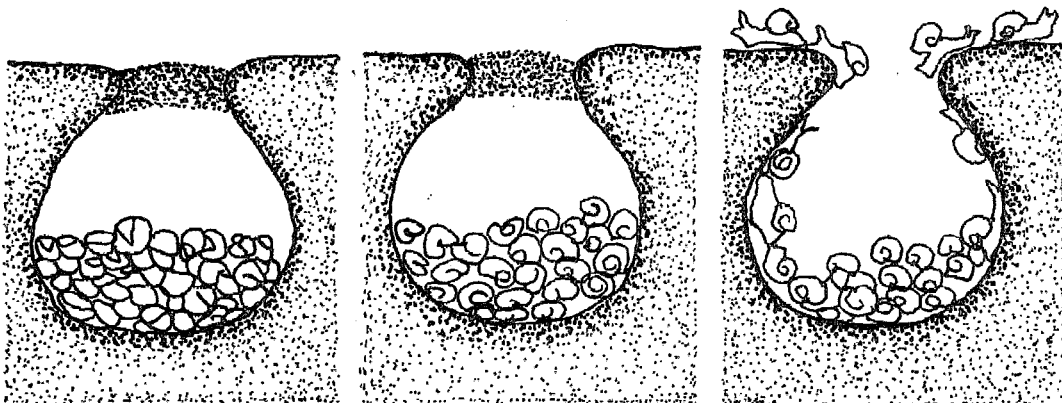

Plants for food and plants for shelter

42. Snails need plants for both food and shelter. Most kinds of snails use several kinds for food and several other kinds for shelter.

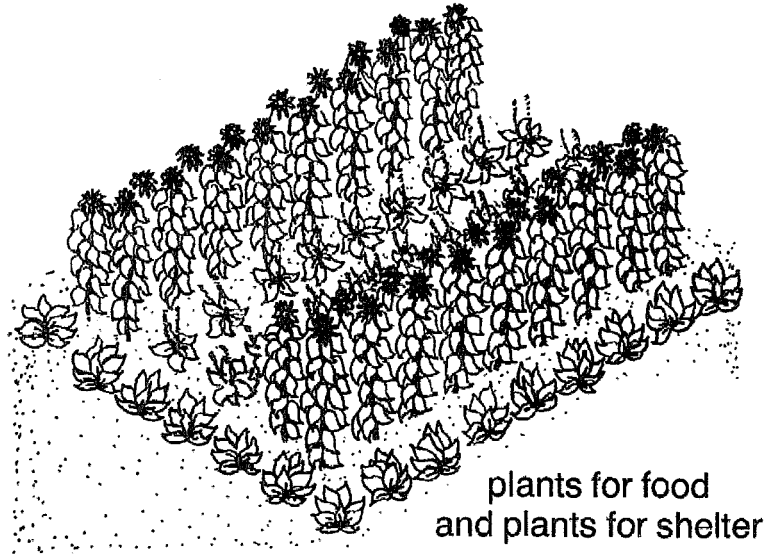

43. They may also use different plants for food and shelter at different times of the year. Sometimes during the growing season snails eat and find shelter on the same plants.
44. Snails usually hide on shelter plants during the day when it is dry and move to food plants to eat at night or early in the morning when they are wet with dew. However, sometimes snails do eat during the day after it has rained.
45. If you live in a place which has a season when plants do not grow, snails will dig into the soil to rest and they do not eat then.

46. During the growing season snails will eat a lot and grow very fast if they have food plants that they like.
47. So, before you begin you will have to find out exactly **what plants they like to eat.** To do this you will have to watch snails at night when they eat.

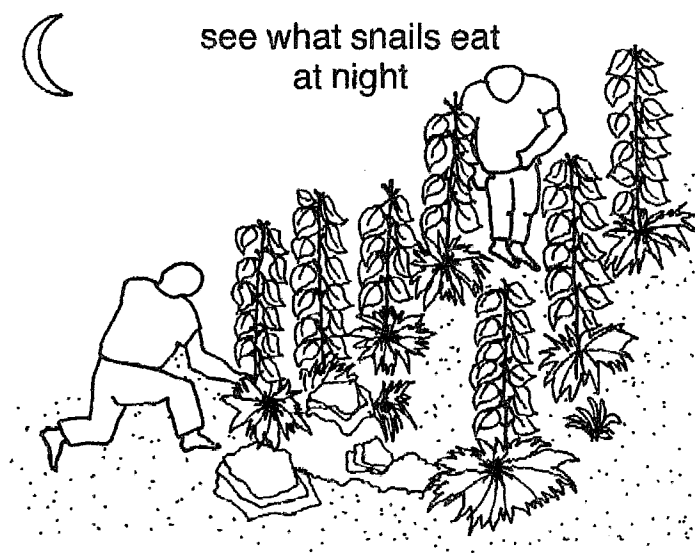

48. You can tell that snails are eating when you see their heads moving as they scrape food into their mouths. You can also tell when a snail has been eating by the holes it makes in the leaves.

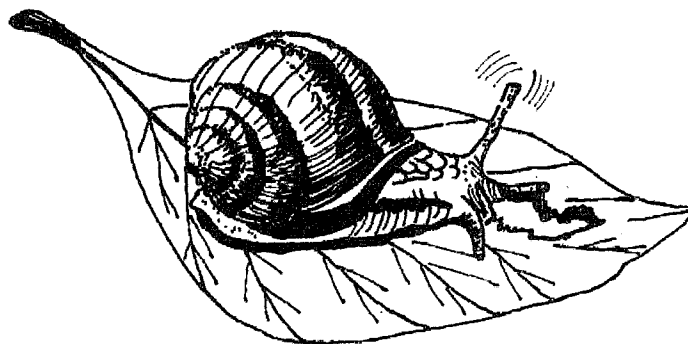

49. You will also have to find out **what plants they like for shelter.**
To do this
you will have to watch snails
during the day when they rest.

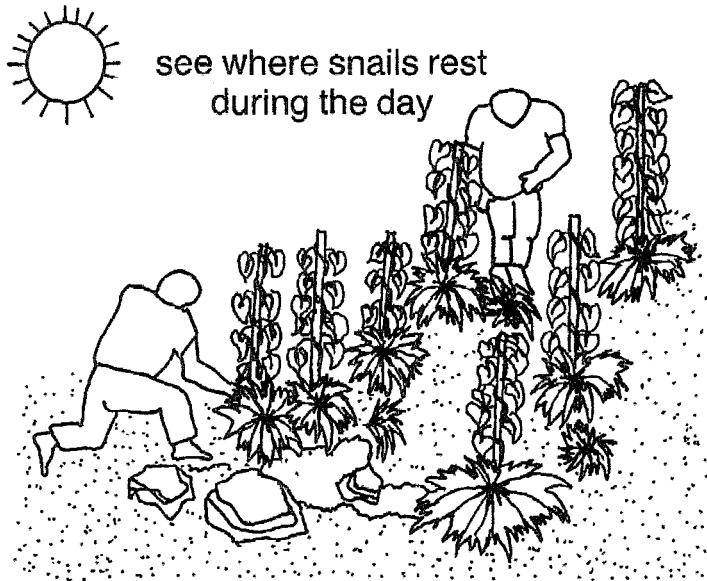

50. It is often difficult
to find snails on shelter plants
because they are hiding.
So, you will have to look
very carefully.

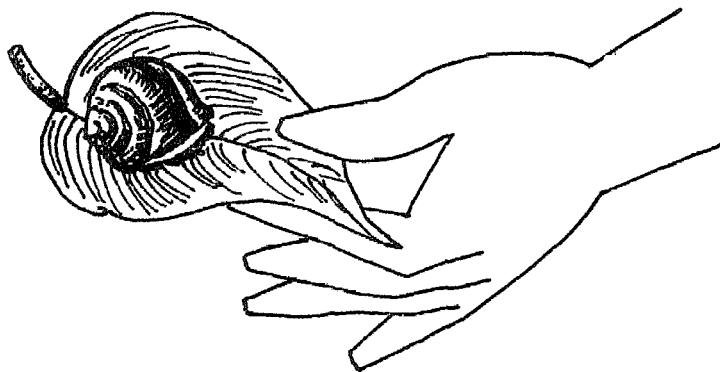

51. In addition to the food plants,
there are many other kinds of foods
that **you can put** into a pen
for your snails to eat.
You will learn about these foods
and when you should use them
in the next booklet in this series.

Dew and rain

52. Dew at night in the growing season helps the plants to grow and makes the leaves and the ground wet so that snails can move about.
53. Rain in the growing season also helps the plants to grow and it cleans the plants of dust and the dirt that snails leave when they move about.
The dirt that snails leave may make them sick.
54. **So, it is very important that the food and shelter plants are wet and clean.**
55. When the leaves are wet, snails move easily, eat more and grow well. When the leaves are dry, snails move very little, or not at all, and they grow poorly.

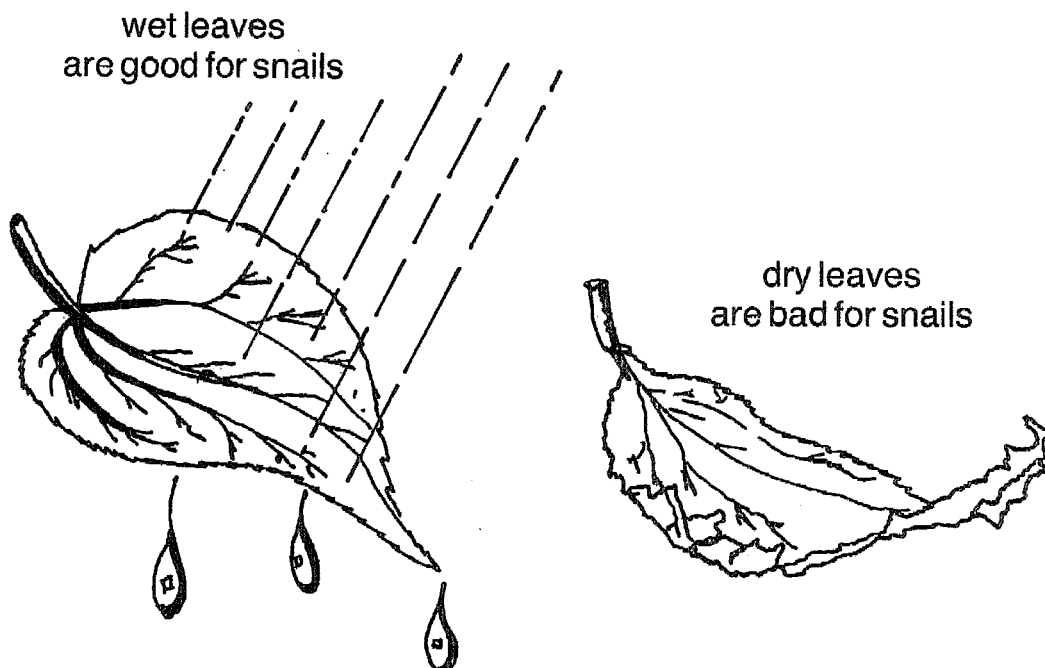

56. When it rains
and the plants are clean,
the snails will be healthy.
When it does not rain
and the plants are dirty,
the snails may get sick.
57. Dew and rain
also keep the ground moist
so that the snails can move easily
and dig into it to rest
and to lay their eggs.
58. In the next booklet,
you will be told
how to wet the leaves of plants
and moisten the ground
when it is too dry.

Land that is wet

59. Land that is very wet,
low land that does not drain well
or land that floods
in the rainy season
is **not** good for snail farming.

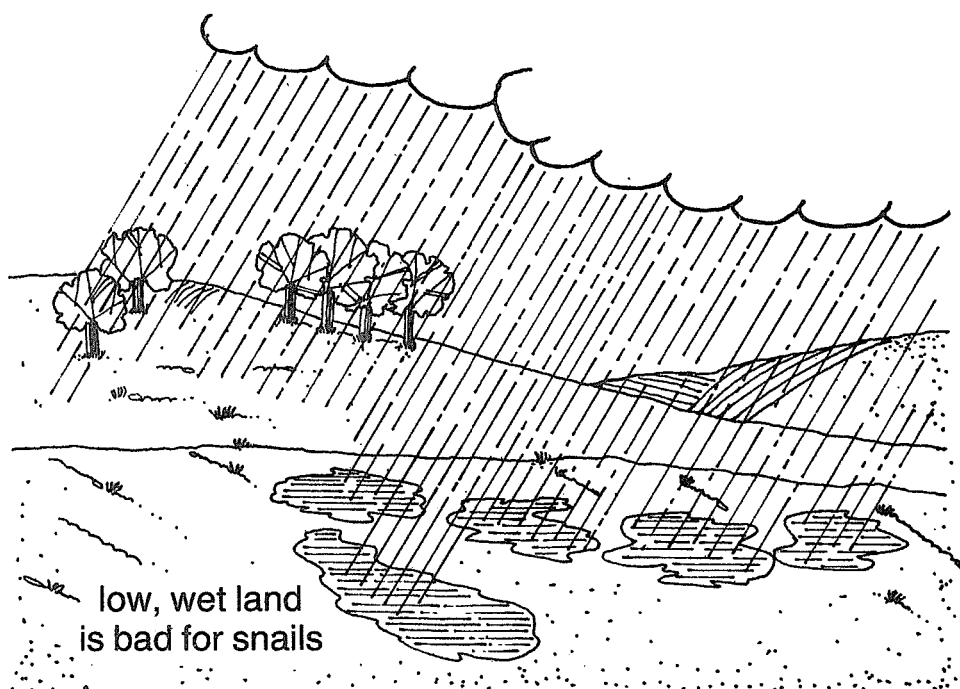

Wind

60. Wind during the growing season is **bad** because it dries the dew and dries out the snails.

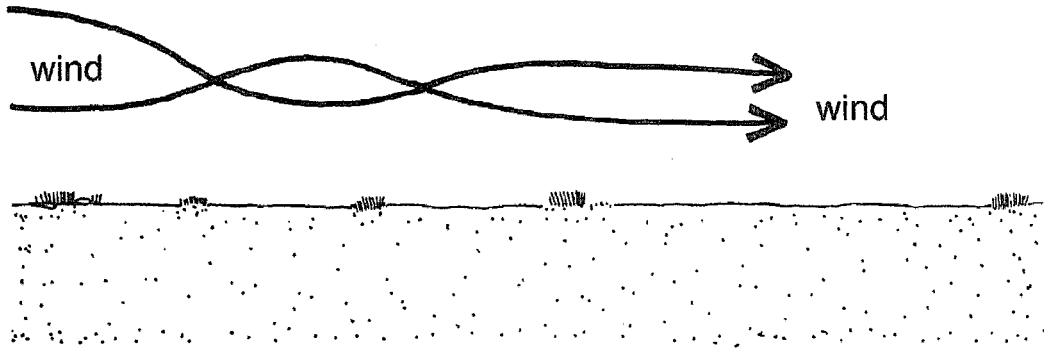

61. If you decide to farm snails, try to keep them in a place that is protected from the wind.

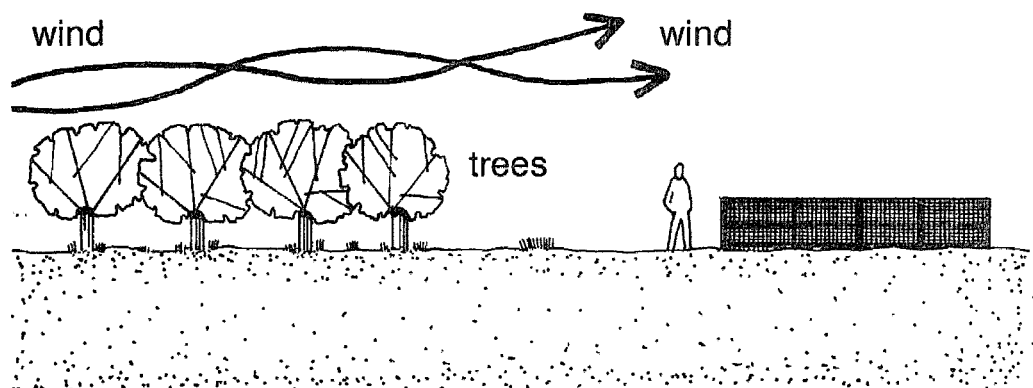
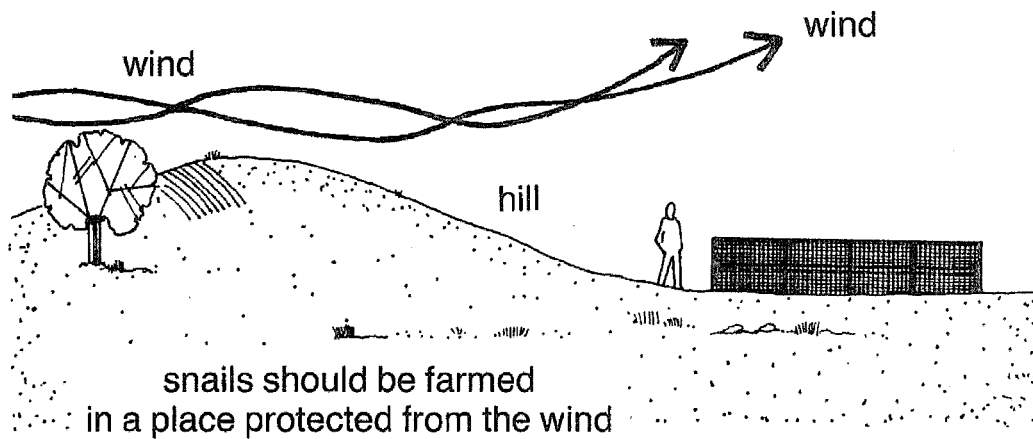

Where do you keep snails when you farm them?

62. If you decide to farm snails you must keep them in a pen. Snails kept in a well-built pen will not get away easily and you can watch them and take care of them well.
63. After the first year you will need **at least** two pens. If you decide to farm more snails you may want **even more** pens. You will learn how to use two or more pens in the next booklet.

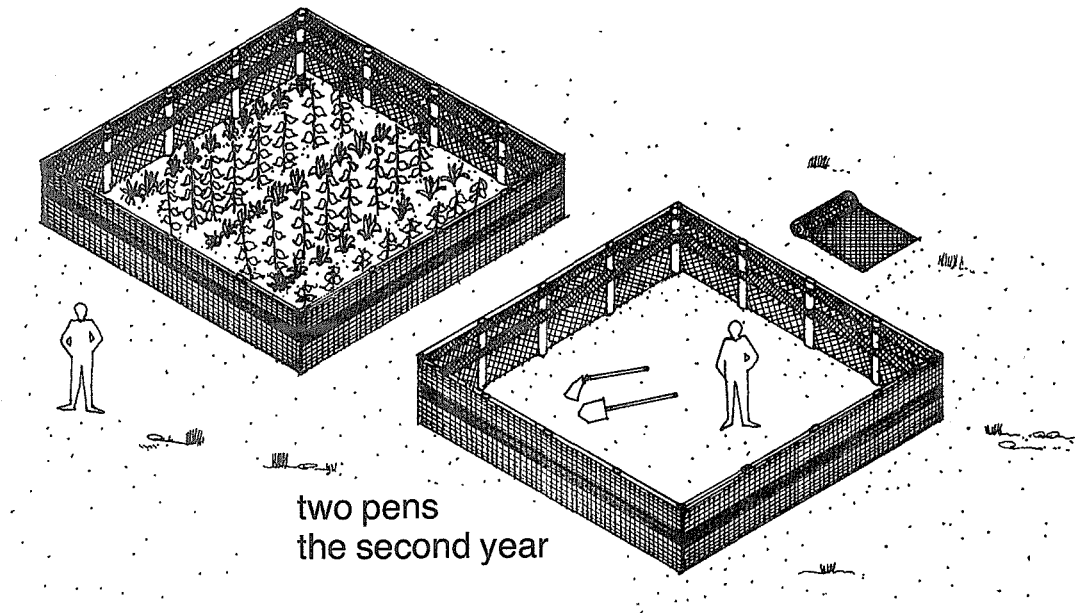

64. In each pen you can give your snails the right kinds of plants for them to eat and to use as shelter.
65. In each pen you can put the food and shelter plants near each other so that the snails can move easily from one to the other.

66. Each pen you build must also keep the snails safe from their enemies. Snails have many enemies. You must be careful to protect them from

- mice and rats
- shrews and moles
- walking insects that live on the ground such as ants and beetles
- slugs and other snails that eat snail meat
- birds that eat snails
- frogs and toads
- thieves

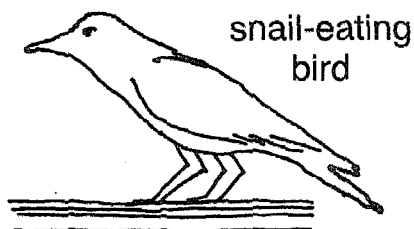
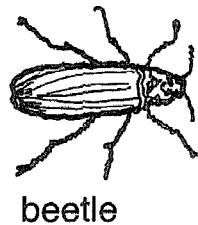
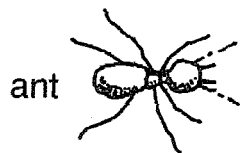
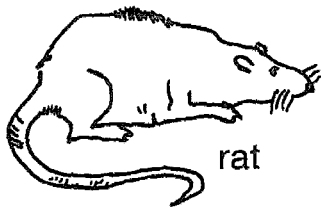

67. A snail pen can be small or large depending on how many snails you want to raise.
However, when you first begin, start with a small pen.
You will need fewer materials.
It will be easier to take care of.
68. In addition, with a small pen you will need fewer snails to begin.
When you know more about raising snails, you can build a bigger pen and get more snails to raise.
69. A good size for a pen is 5×5 metres.
Later in this booklet you will learn how to build a small pen of this size.

How many snails will you need when you first begin?

70. If you are using **small snails** like those you have seen on pages 8 and 9 in this booklet, you will need **more** snails to begin.
71. If you are using **large snails** like those you have seen on pages 10 and 11 in this booklet, you will need fewer snails to begin.
72. With a pen of 5×5 metres (25 square metres) you will need
- 150 snails if you use the small kind (6 for each square metre)
 - 25 snails if you use the large kind (1 for each square metre).

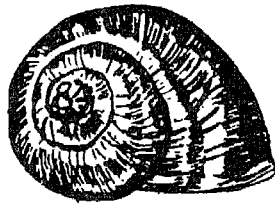

150
SMALL
SNAILS

25
LARGE
SNAILS

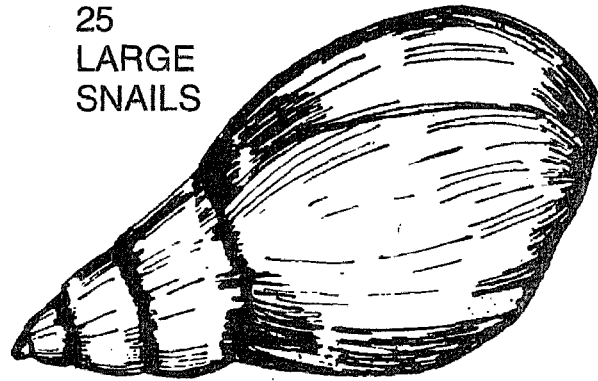

How much snail meat can you expect to get?

73. The amount of snail meat that you will get from small snails will be about the same as what you would get from large snails. This is because you will use many more small snails than large snails and the meat will be about equal.
74. With one 5×5 metre pen you will get 12 to 13 kilograms of snail meat each year and with two 5×5 metre pens you will get 24 to 26 kilograms each year.

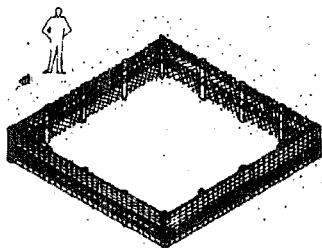

= 12 to 13
kilograms
each year

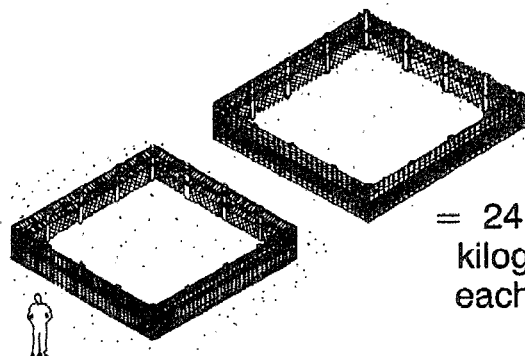

= 24 to 26
kilograms
each year

Now you must decide

75. In the first part of this booklet you have learned many things about snails and farming snails. You have learned
- why it is good to farm snails
 - what you need to farm snails
 - what kinds of snails you can farm
 - how to find plants near you that are good for food and shelter
 - what kind of soil and how much water in the soil snails need
 - where to keep snails and how many you need to start
76. You may also have been able to learn a lot about snails by watching the wild snails near where you live.
77. An old farmer may have told you what he knows about snails. Someone who gathers snails to sell to others or another snail farmer may have helped you to learn.
78. So, now that you know a lot about snails it is time to decide if you would like to start your **own** snail farm.
79. **If you would like to begin you will learn exactly what to do in the rest of this booklet and in the next booklet.**

HOW TO BEGIN

Choose a place on your land to put your snail farm

80. Try to choose a place that is close to your house. That way you will be able to watch your snails, protect them from their enemies and take care of them easily.

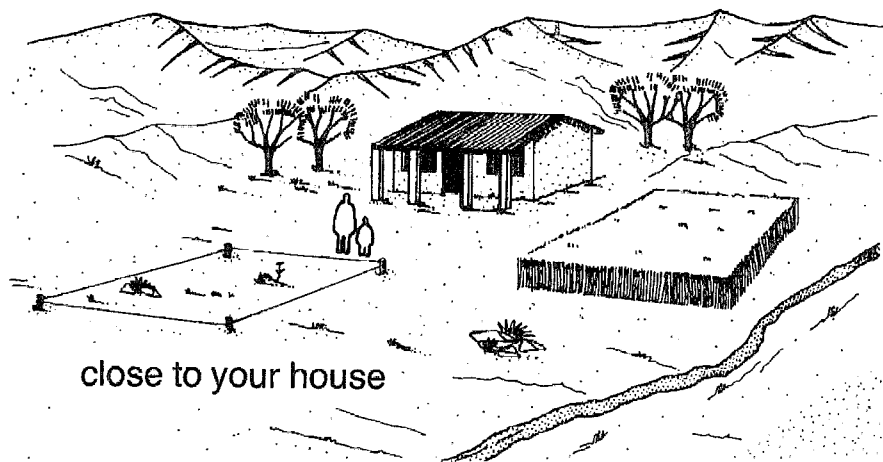

81. In Items 34 to 41 you were told that to farm snails you must have the right kind of soil with the right amount of water.
82. Remember, if green leafy vegetables grow well in your soil, snails will also grow well in the same kind of soil.



83. In Items 59 to 61 you were told that low, wet land and wind are bad for snails. So, avoid low, wet places and try to put your snail farm where it is protected from the wind.

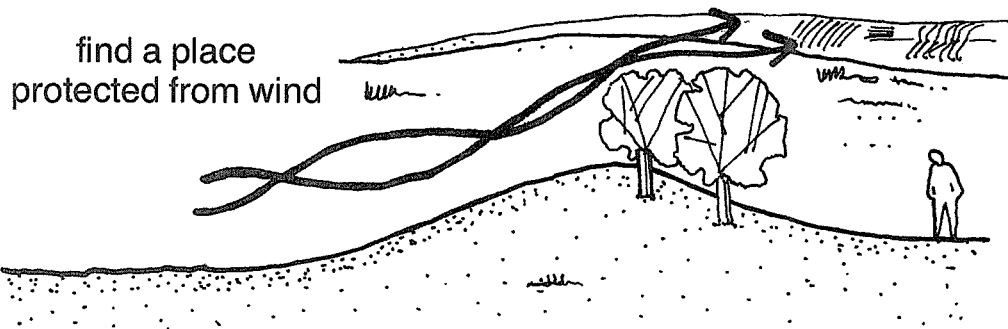
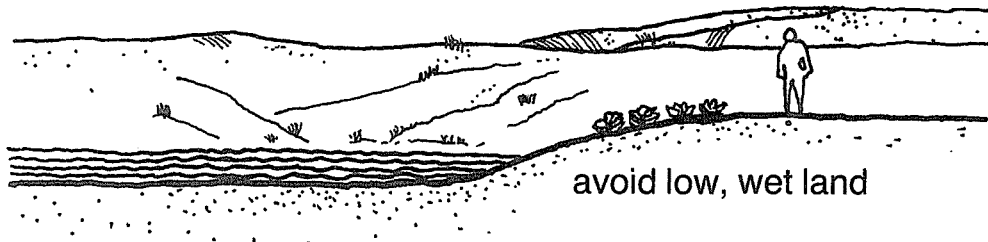

84. In Item 63 you were told that after the first year you will need **at least two pens** and later you may want even more. In Item 69 you were told that it is best to start with a small pen of 5×5 metres.

85. So, try to find a place where you can put at least two or three 5×5 metre pens.

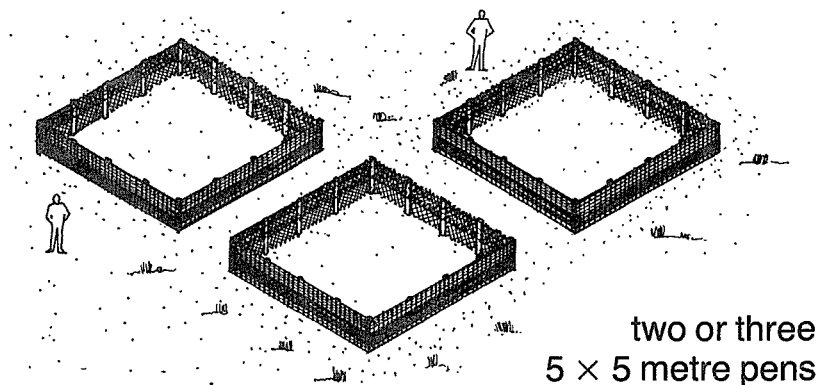

Clean the site and prepare the ground

86. Clean the site and prepare the ground a little before the growing season so that you can build the pen in time to plant the food and shelter plants.
87. First, mark out a square of 8×8 metres on the place that you have chosen.

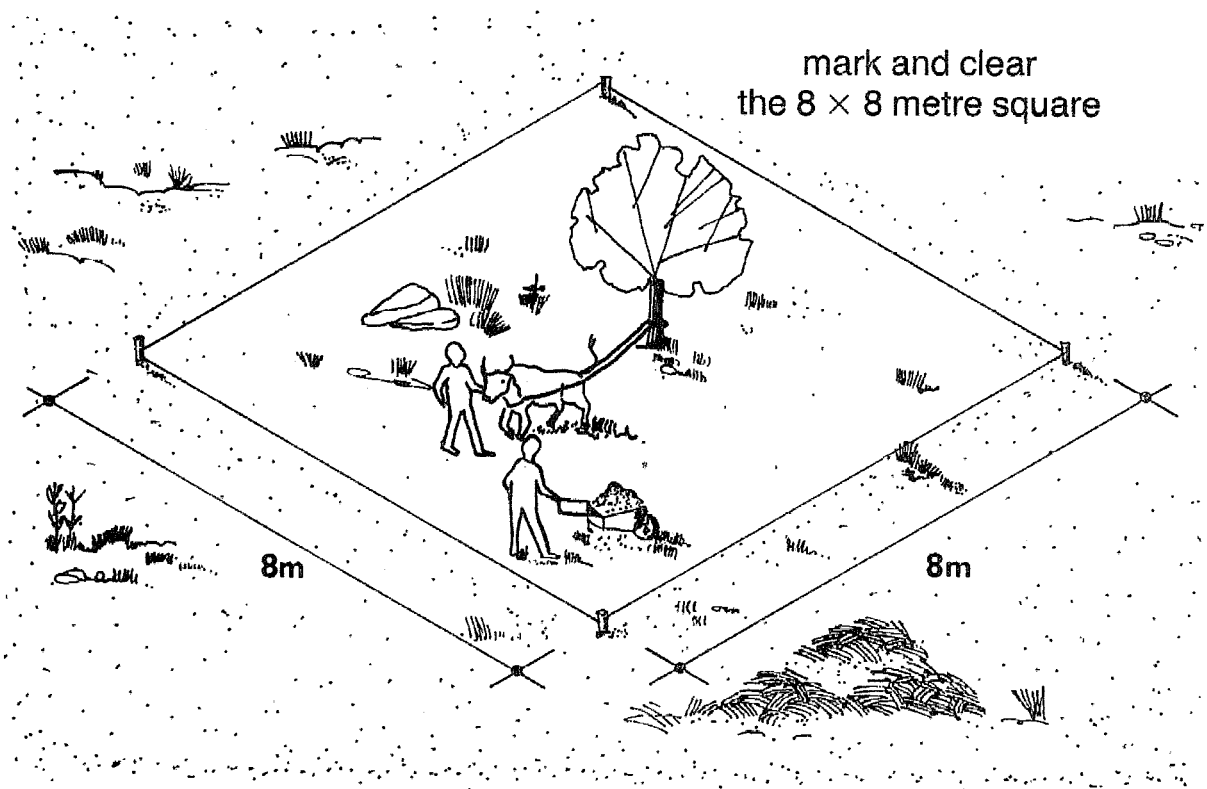

88. That way, with a pen of 5×5 metres in the centre of the square, you will have a path of 1.5 metres all the way around it (see Item 92). If you have enough land, the path can be even wider.
89. Clear the square of trees, bushes grass, creeping grass and weeds. Take away all of the roots and the big stones that you can.

take away roots
and big stones

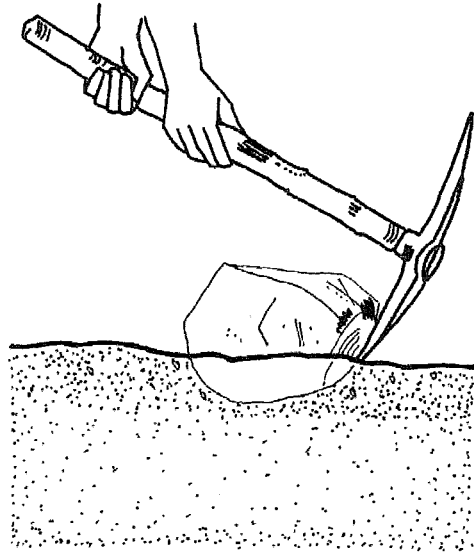
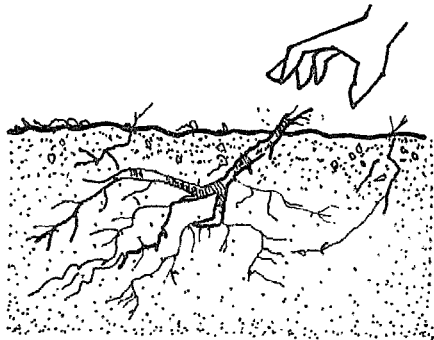

90. Spread the plant material that you have cleaned evenly on the ground and cover the whole square. If there is not enough, bring more plant material from another place.

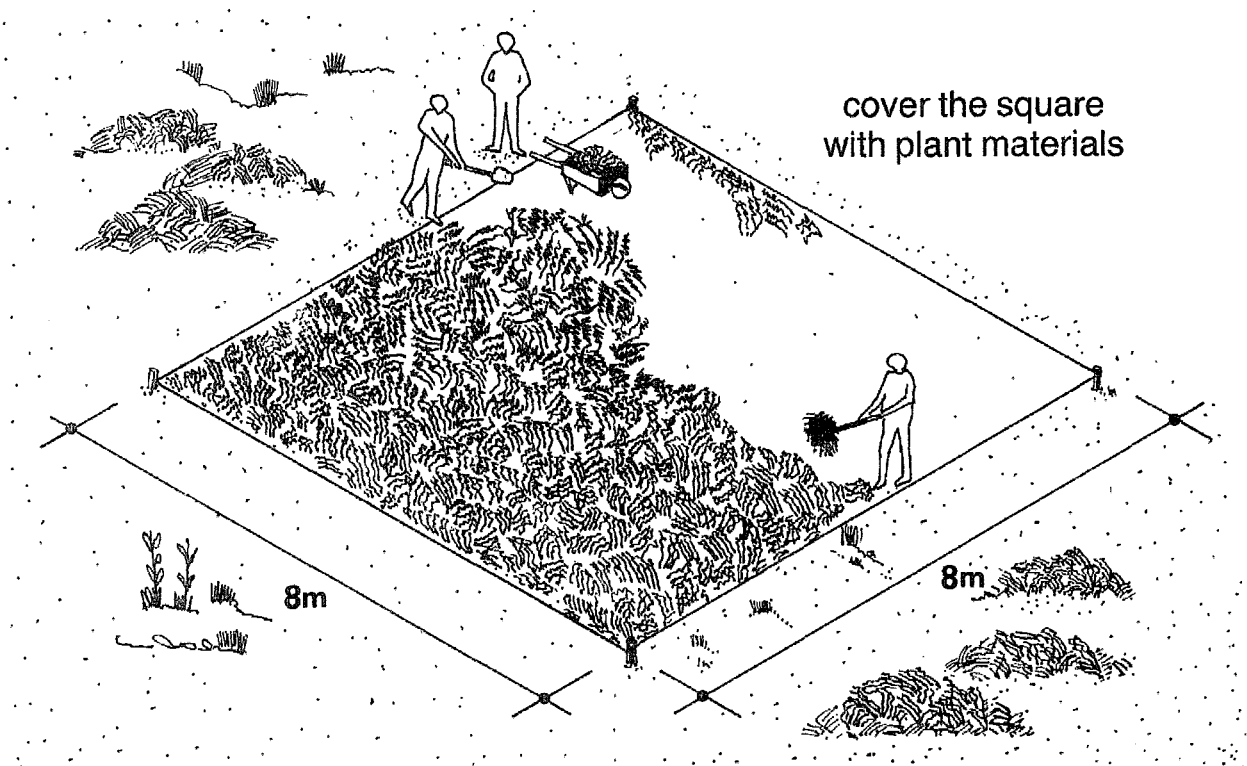

91. When the plant material is dry, **burn it.**
This will kill the insects,
the weed seeds
and the roots of creeping grass,
and rid the ground
of mice, rats and shrews.

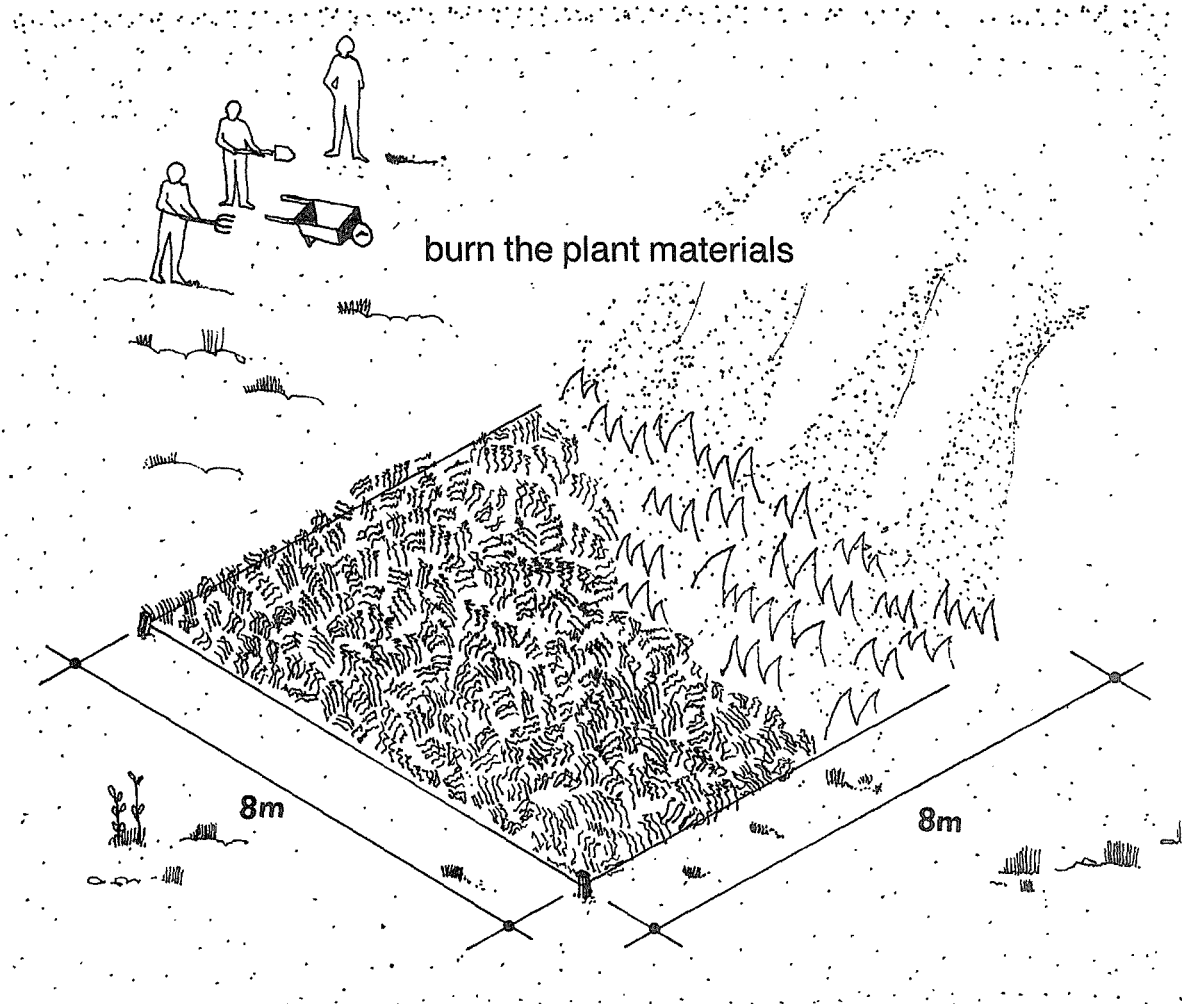

Note

Insecticides and poisons
can also be used to rid your pen
of insects, mice, rats
and other enemies of snails.
However, if you use them,
**do not use them by yourself
because they are very dangerous.**
Ask someone who knows how to use them,
such as your extension agent.

92. Now mark out a smaller square of 5×5 metres inside the big square. This is for your first snail pen.

mark the 5×5 metre square

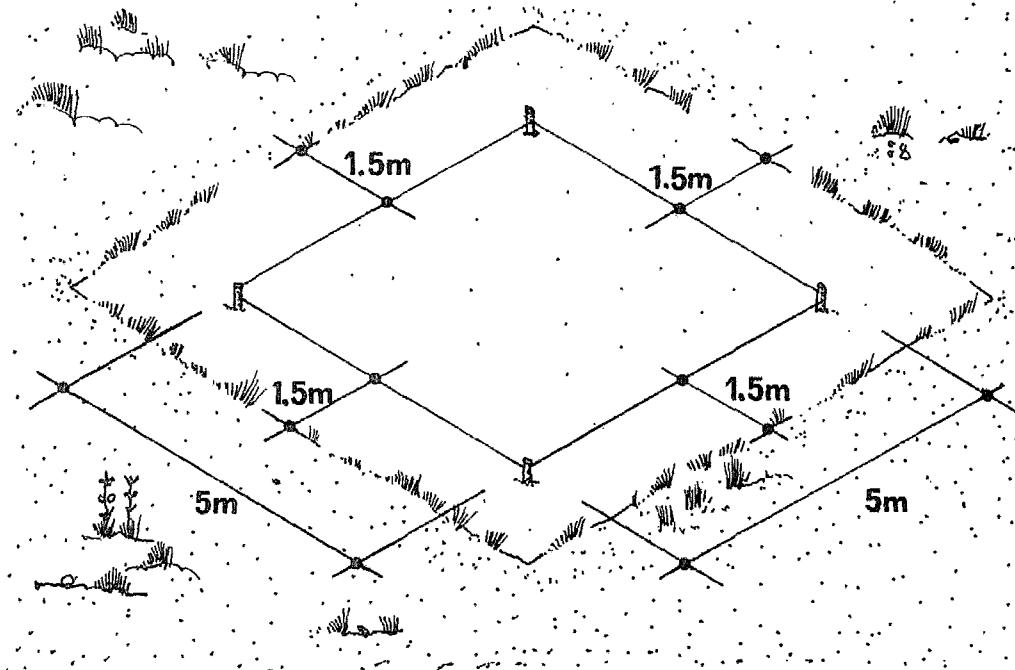

93. Dig the ground in the smaller square to a depth of 20 centimetres and turn it over well. As you dig, remove any rubbish or roots that you find.

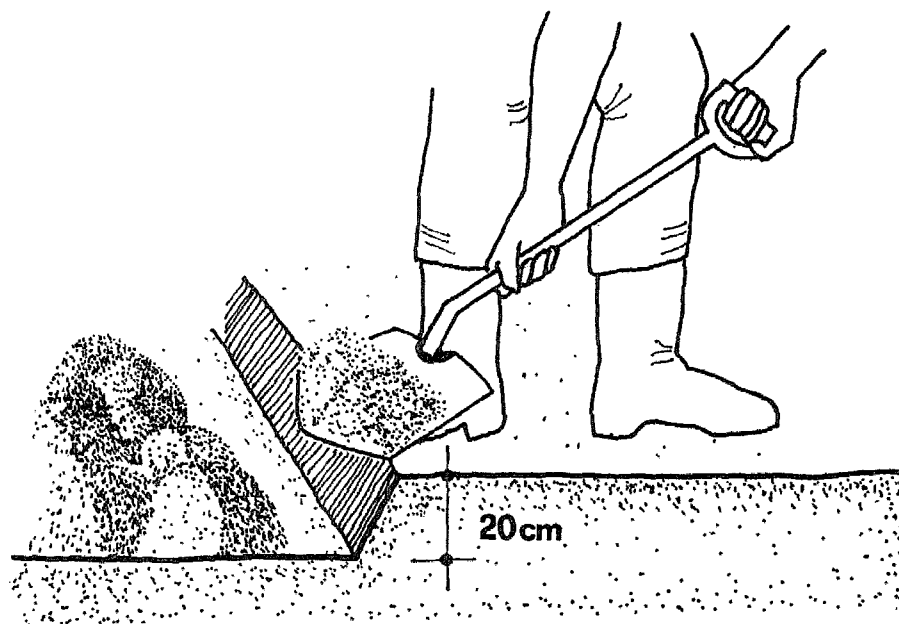

94. While you are digging, if you see any more insects or any of the enemies of snails, bring more dry plant material and burn the ground again. **To farm snails, the area must be free of insects, mice, rats and other enemies.**
95. When you have finished digging, the ground in the 5 × 5 metre square should be as smooth and well worked as it would be if you were planting a vegetable garden.

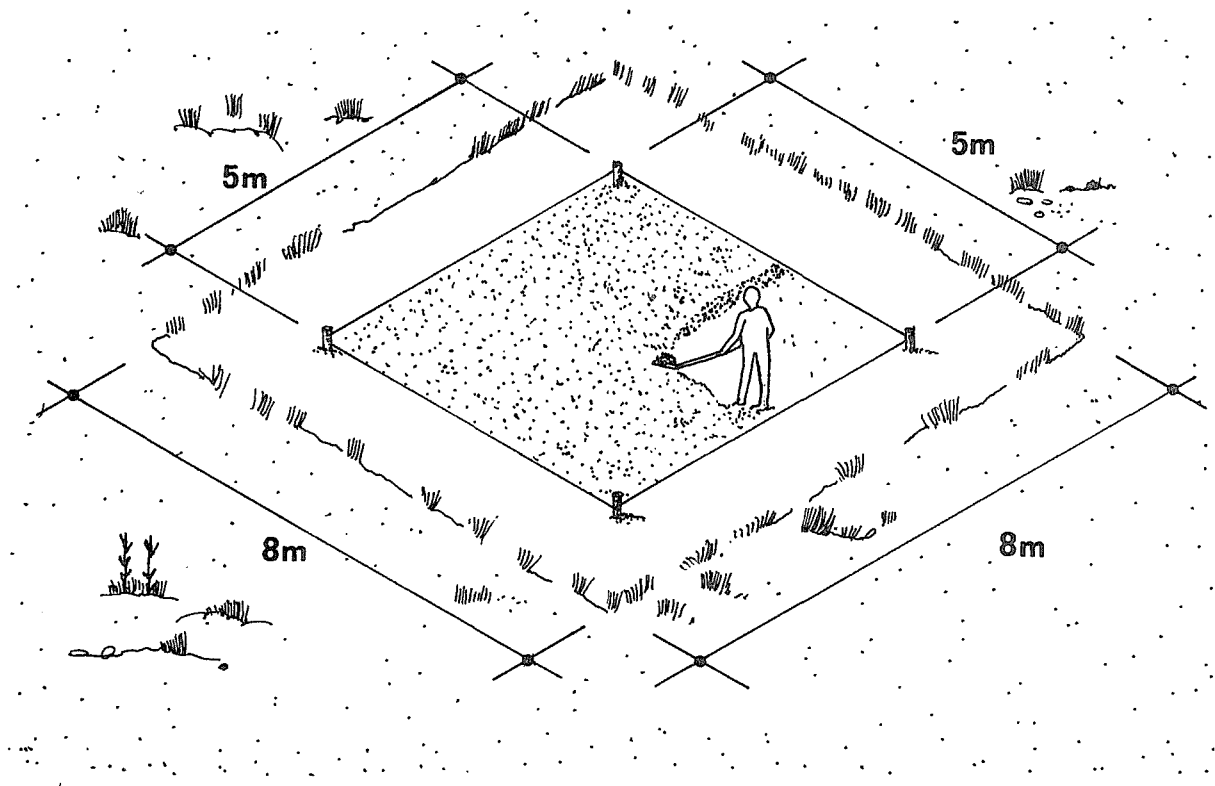

96. **However, do not use any fertilizer, animal manure or compost** as you might with a vegetable garden. Fertilizers may burn the snails and animal manure or compost may bring in insects and weed seeds.

BUILDING A PEN

97. Build a pen for your snails as soon as you can after you have burned the plant material. This is to keep other insects, mice, rats or shrews from getting into your pen.
98. A snail pen is a simple fenced-in area and you can build a fence using
- corrugated sheet metal or plastic sheets
 - woven plant material
 - woven plant material with chicken wire

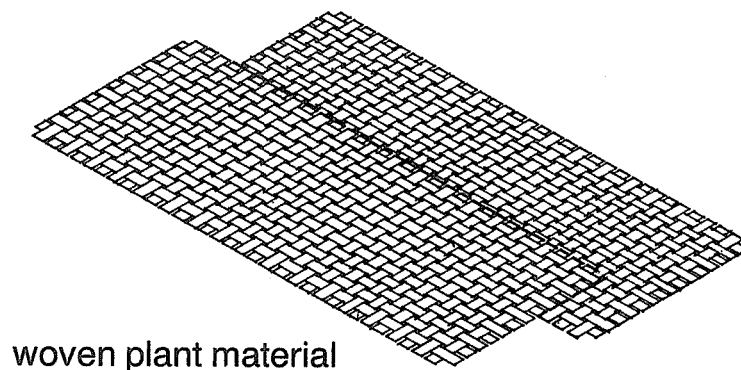
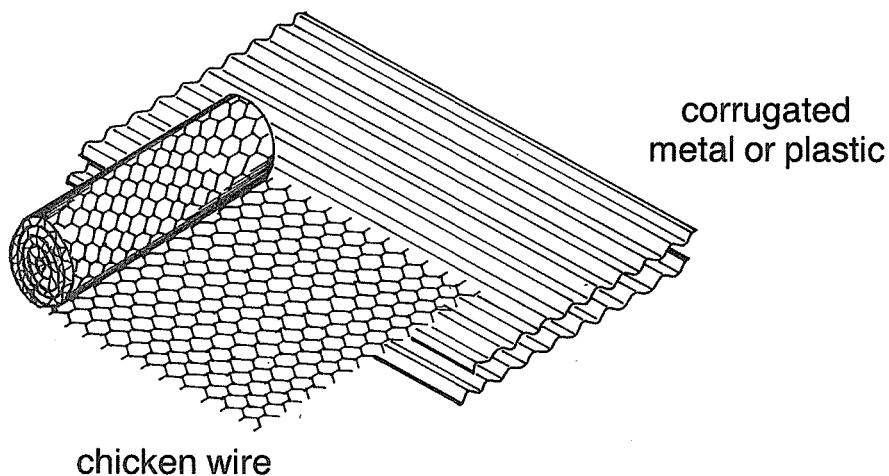

Using corrugated sheet metal or plastic sheets

99. A fence of corrugated sheet metal or plastic sheets makes the best pen for snails because it keeps out their enemies very well. However, sheet metal or plastic costs a lot of money.

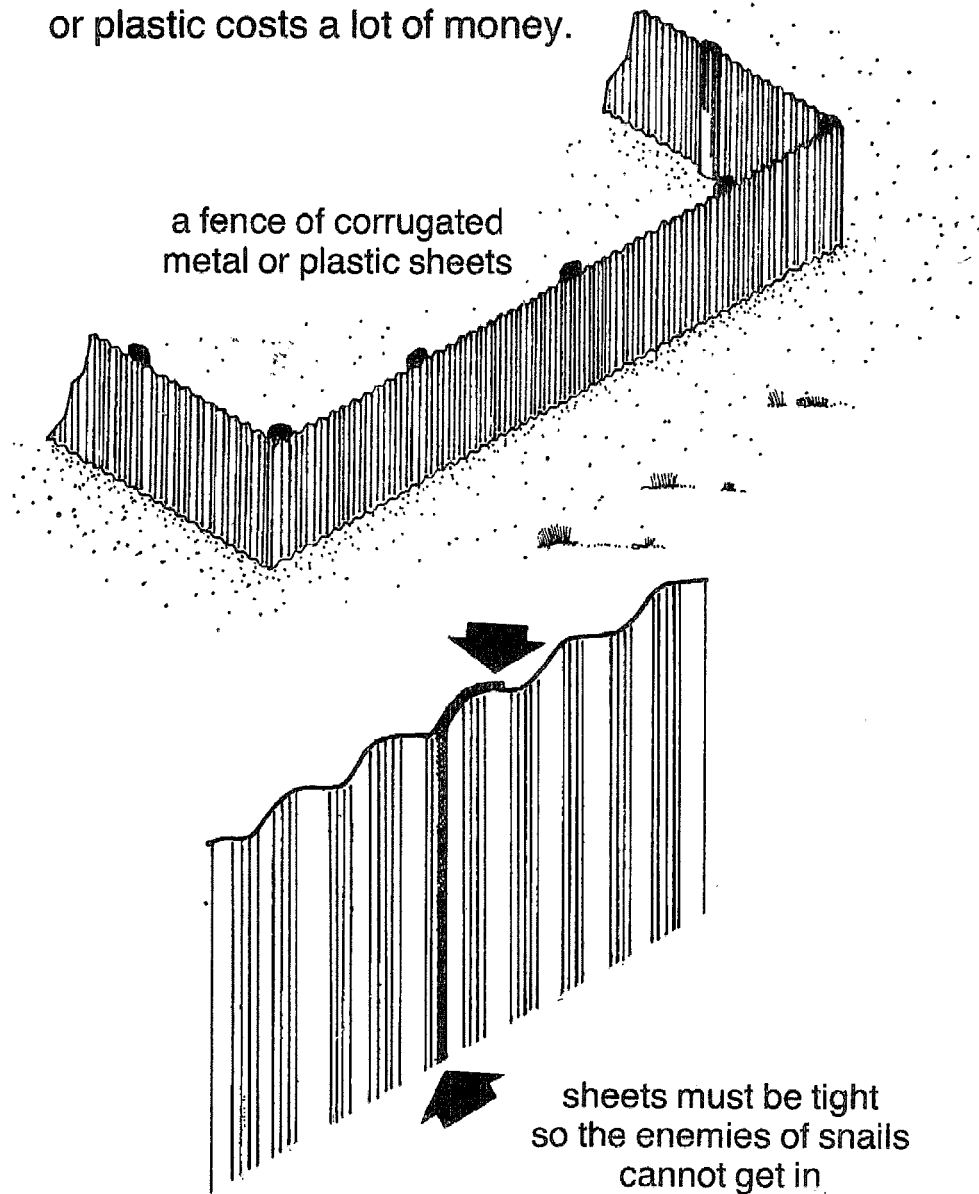

100. If you are going to build a pen using corrugated metal or plastic, you must build it in such a way that the enemies of snails cannot get in between the sheets.

Using woven plant material

101. To save money, you can build a fence of woven plant material such as split bamboo. If the woven material is tight, it will keep out enough of the enemies of the snails for you to farm snails.

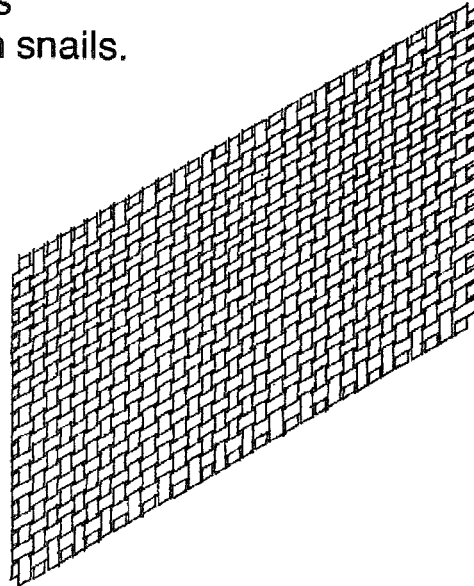

woven material

Using woven plant material with chicken wire

102. If you can get fine-mesh chicken wire, you can improve a fence that is made of woven material.

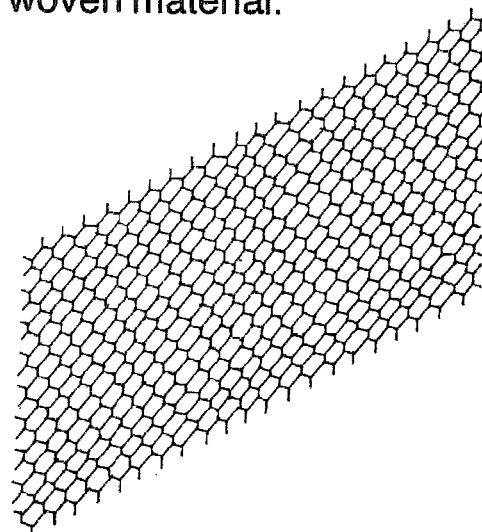

chicken wire

103. To do this,
first make the fence
of chicken wire
and then cover it
with woven material.

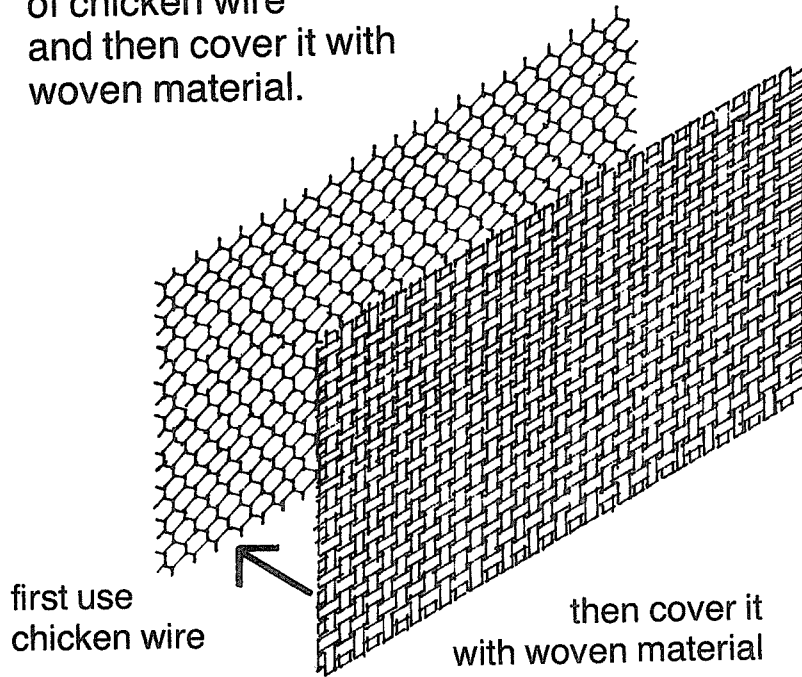

104. The chicken wire will keep out
rats and other small animals.
The woven plant material
will keep most of the insects out
and keep the snails in.

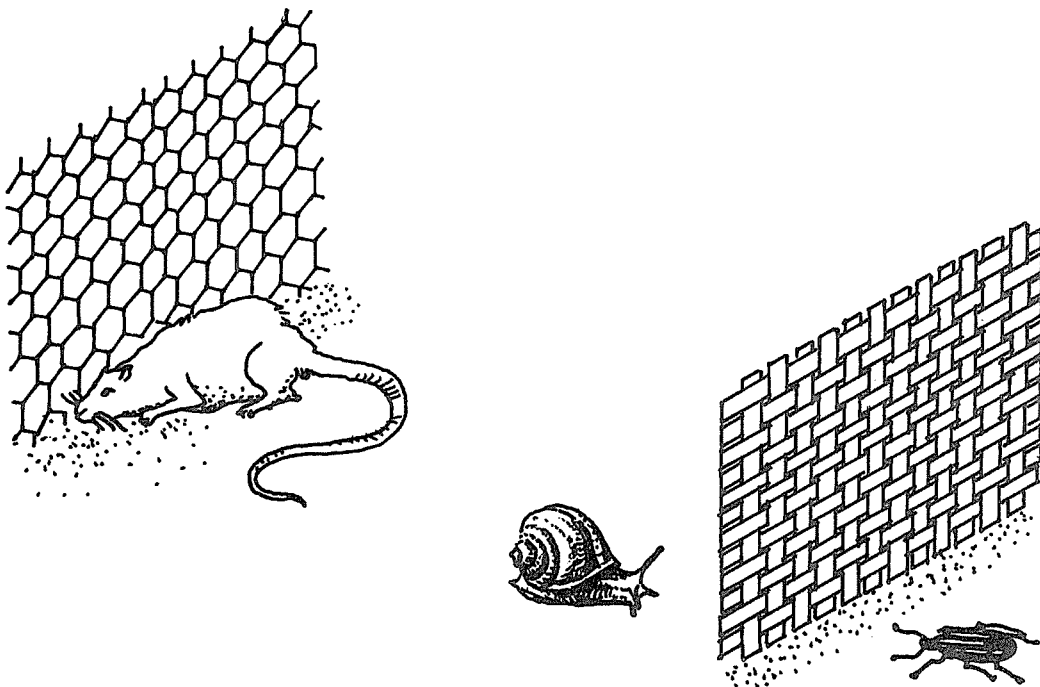

Note

With **any** kind of pen animals such as rats may get in, and this is especially true with pens made only of woven plant material. So, you must **always** watch for rats and other animals and keep them out.

How to build the fence

105. Build the fence as you would any fence, by driving posts into the ground. Use posts 1.40 metres long. When the posts are in place they should be 1.00 metre above and 0.40 metre below the ground.

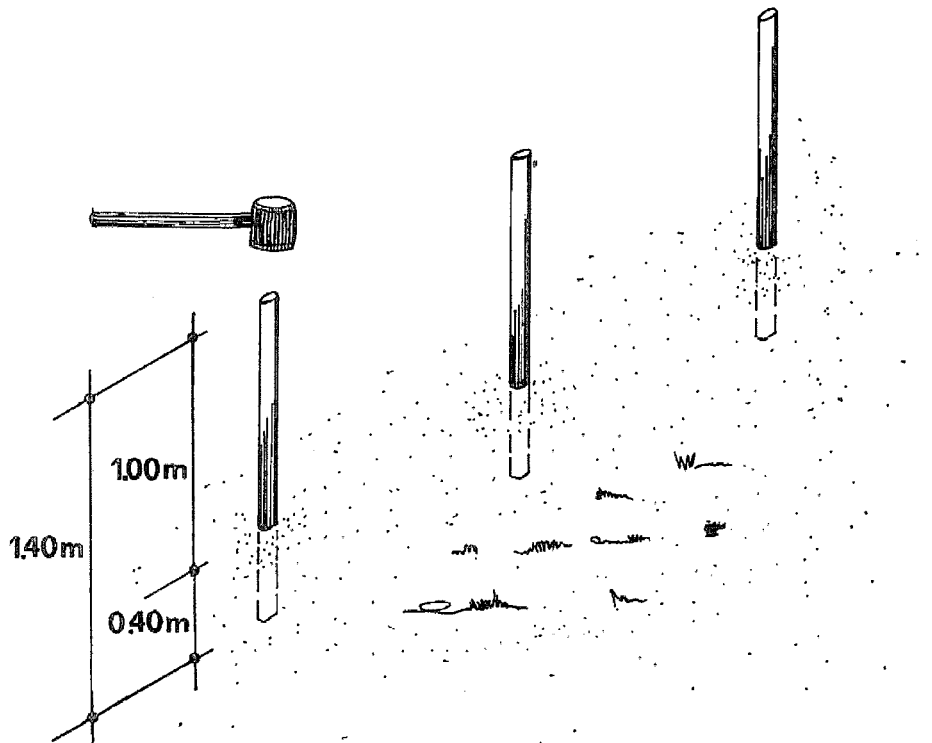

106. Whatever material you use for the fence of your pen, it should be buried 0.40 metre below the ground.

107. If you are using woven material you will have to change the bottom of the fence when it rots.
108. This can be done more easily by making the woven material in two parts, one for the top and one for the bottom. When the bottom part rots, you can change it without having to change the whole fence.

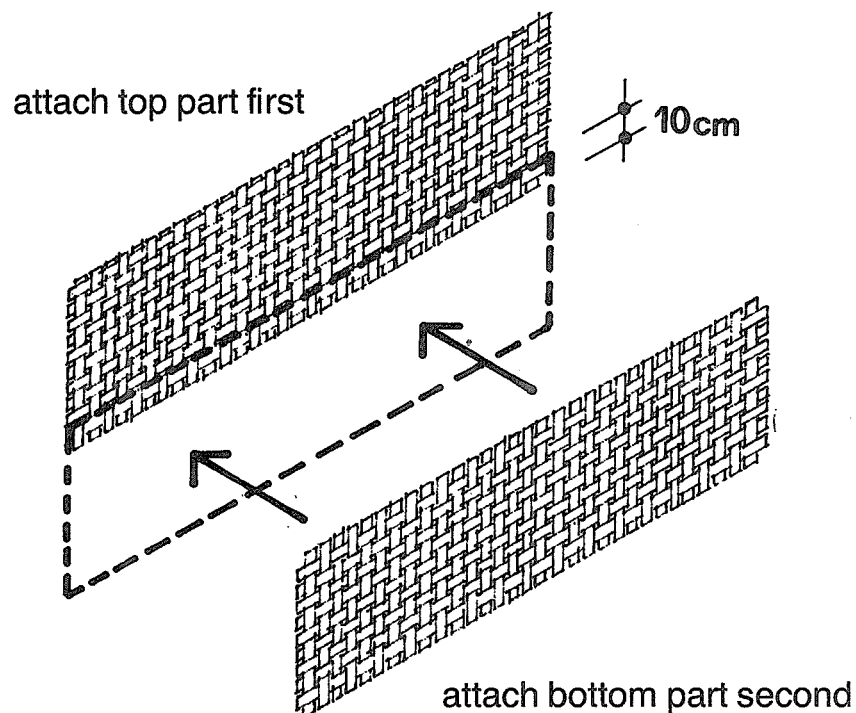

Keeping your snails in the pen

109. Many of your snails may crawl over the fence and get out of the pen. If you build a flap on the inside at the top of the fence, it will be more difficult for your snails to get out.

110. However, even with a flap some snails may get out, and for this reason many snail farmers put two flaps on their fence. With two flaps they find that fewer snails get out.

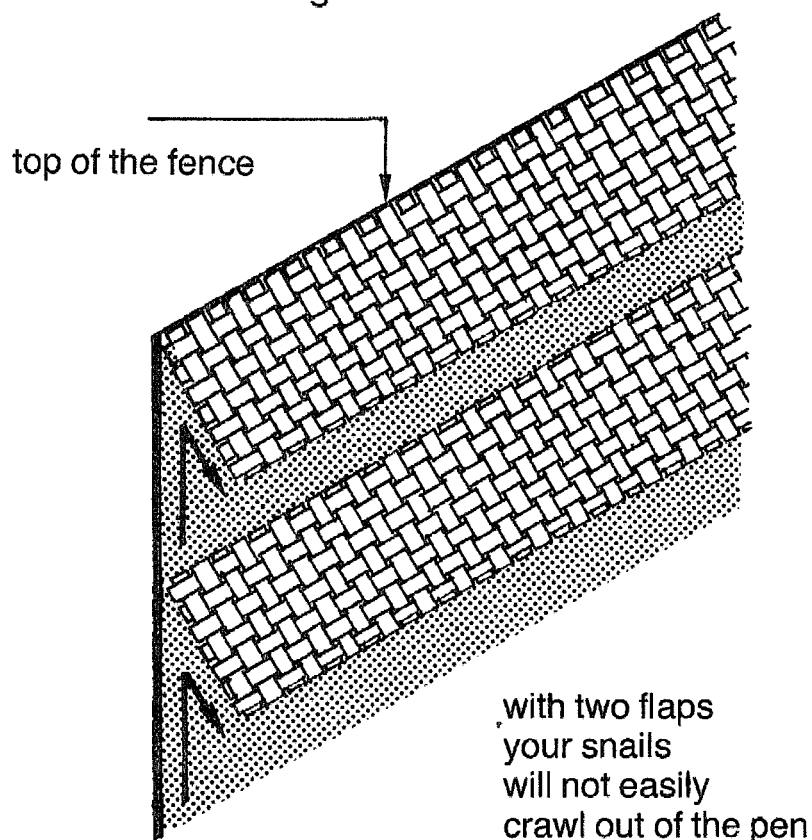

Note

If you make your pen using galvanized sheet metal, you will not need flaps. Snails will not crawl on galvanized sheet metal.

111. The drawings on pages 43 to 46 show you how to build a 5 × 5 metre pen using woven plant material, with and without chicken wire, and how to build flaps to keep your snails in.

How to build a 5 × 5 metre snail pen

- 1 drive the posts into the ground for the fence of your snail pen

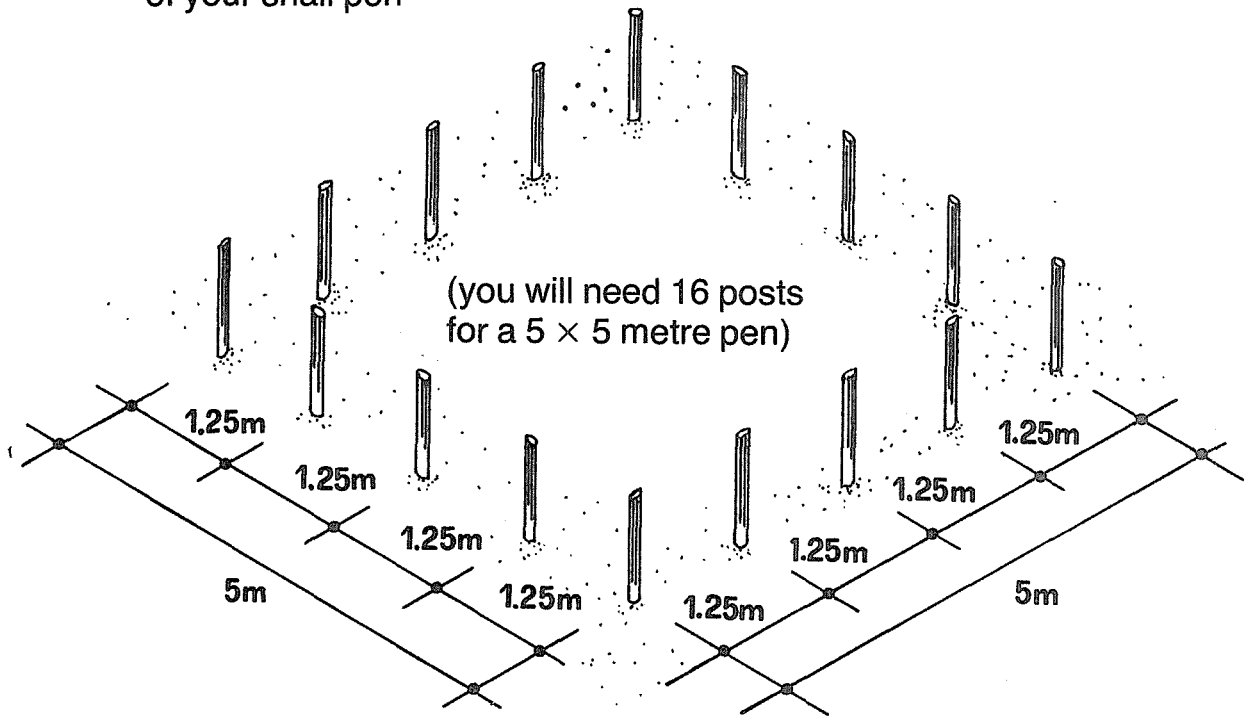

- 2 dig a trench 0.40 m deep all the way around the pen, outside the posts, to bury the fence cover (see Item 106)

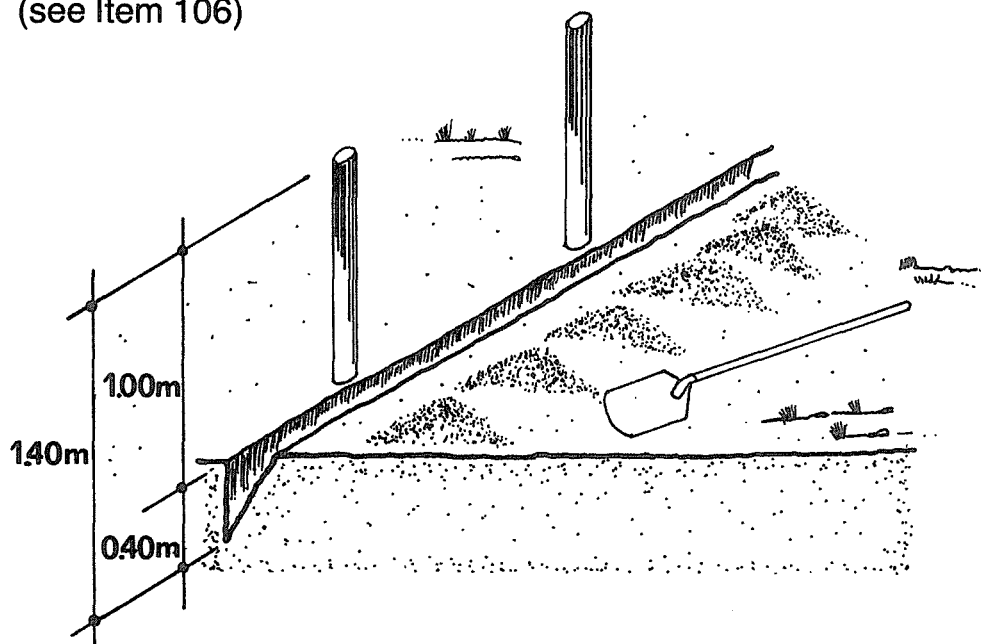

- 3 if you are using woven material only, attach it as you were told to do in Item 108

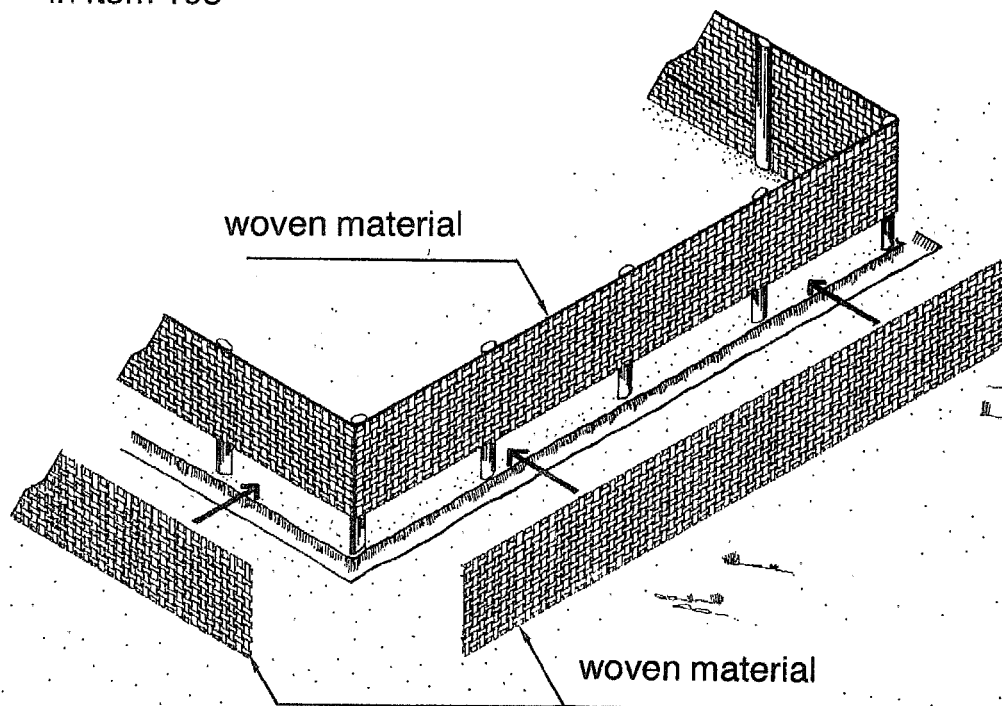

- 4 If you are using chicken wire and woven material, attach the chicken wire first and then the woven material

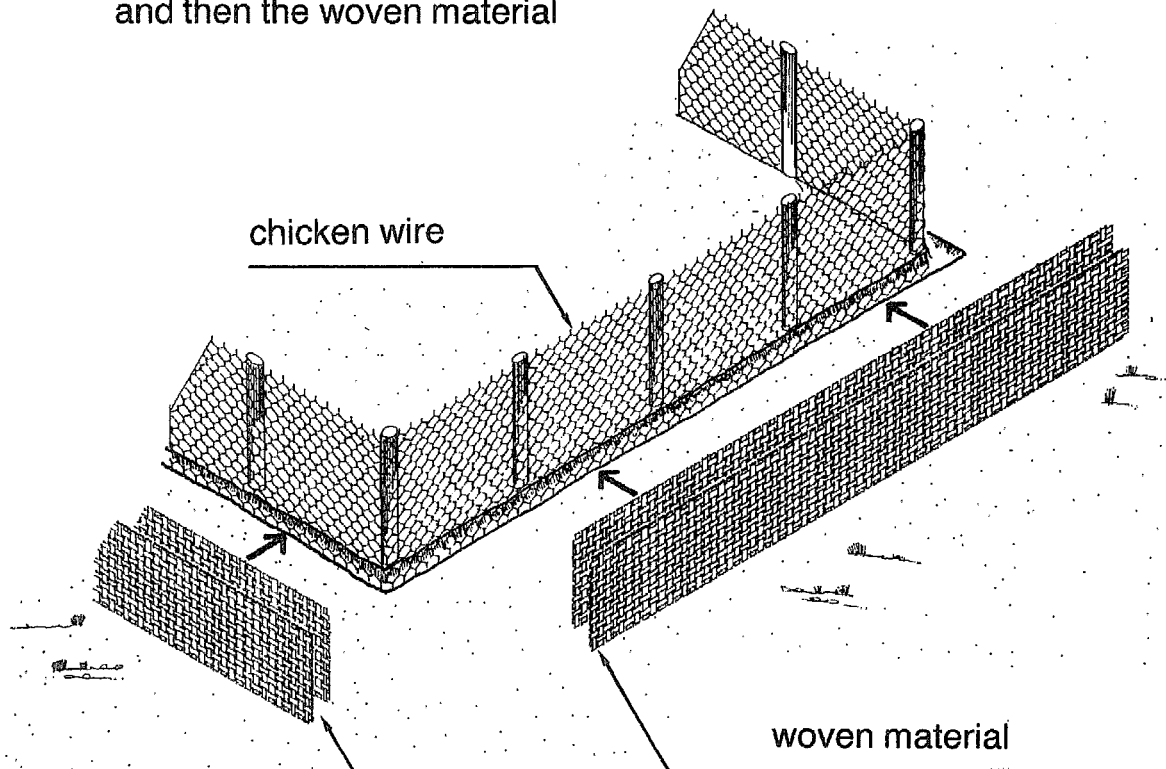

- 5 be sure that the fence cover goes all the way to the bottom of the 0.40-m trench

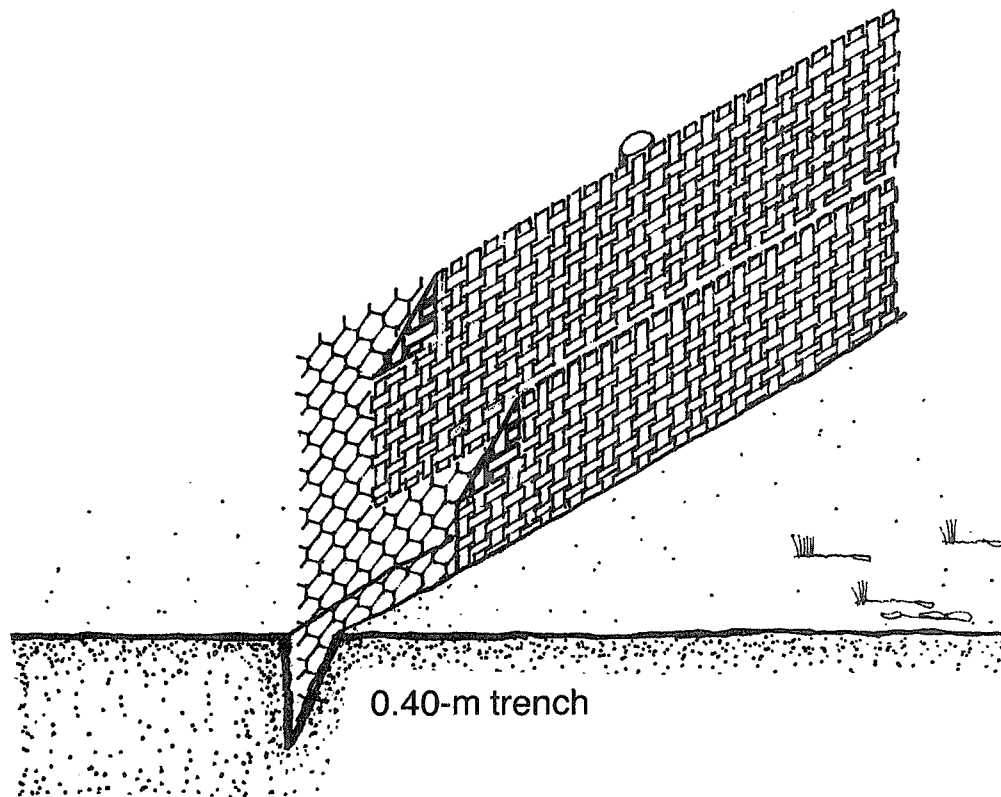

- 6 fill in the trench

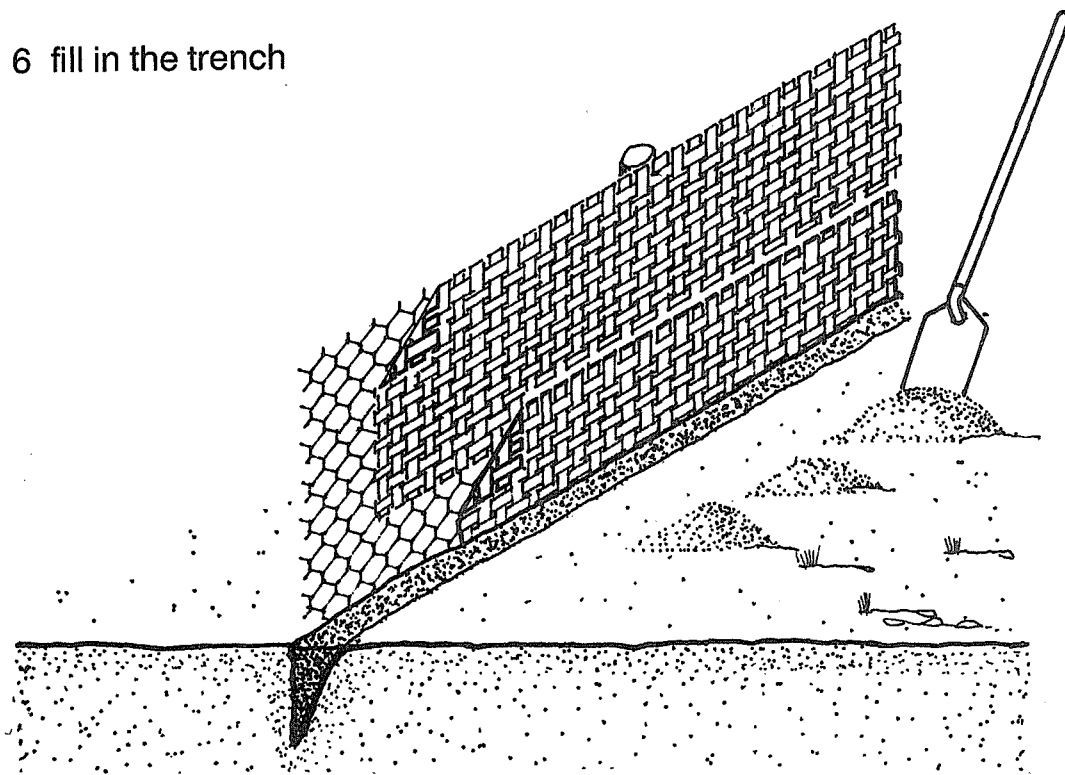

7 attach the flaps
to the inside of the pen

Note

use woven material
0.25 m wide
for the flaps

8 first attach
the bottom flap
using heavy cord

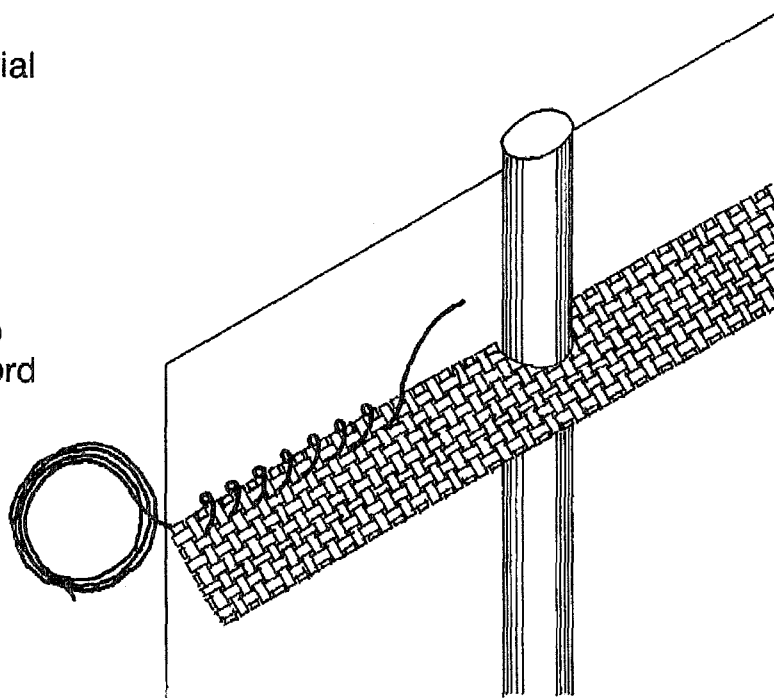

9 then attach
the top flap

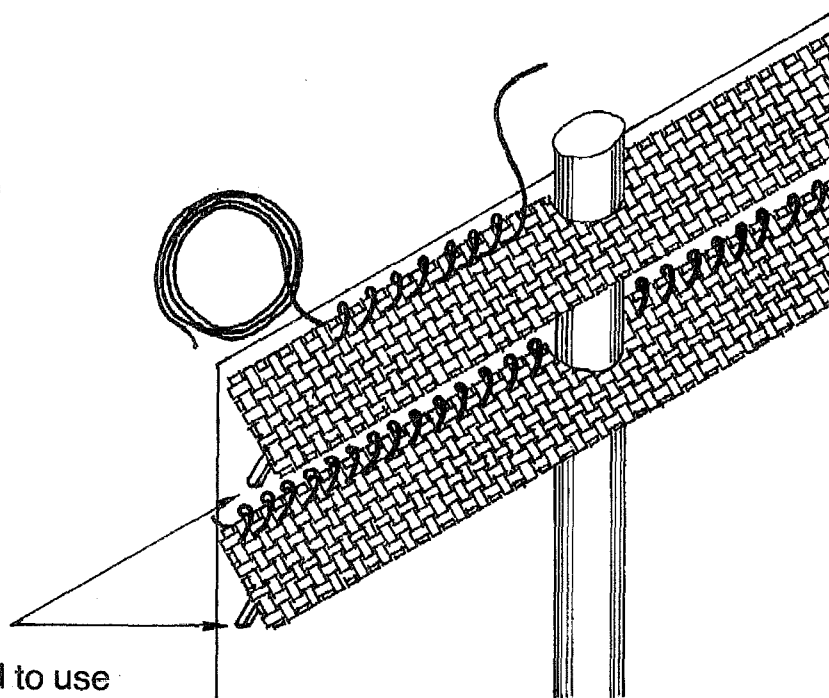

Note

you may need to use
short wood sticks
to hold the lower part
of the flaps
away from the fence

PLANT THE FOOD AND SHELTER PLANTS

112. You have already been told that you should clean and prepare the site and build your snail pen in time for the planting season.
113. If it has been only a short time since you dug the ground and worked the soil in your pen, you can begin to plant.
114. If it has been a long time, dig and work the soil again before you plant. However, as you were told in Item 96, **do not use fertilizer, animal manure or compost.**
115. Now you can begin to plant the food and shelter plants. Remember that you should use
- plants that grow well where you live
 - plants that last a long time
 - plants that snails like
116. The drawings on pages 48 and 49 show you two ways to plant food and shelter plants in a 5 × 5 metre pen.
117. On pages 50 to 55 you will see some food and shelter plants that snails are known to like. **Look at them carefully.** Perhaps you can find some of them where you live.

*Two ways to plant
food and shelter plants*

- 1 if your shelter plants are small,
plant your pen like this

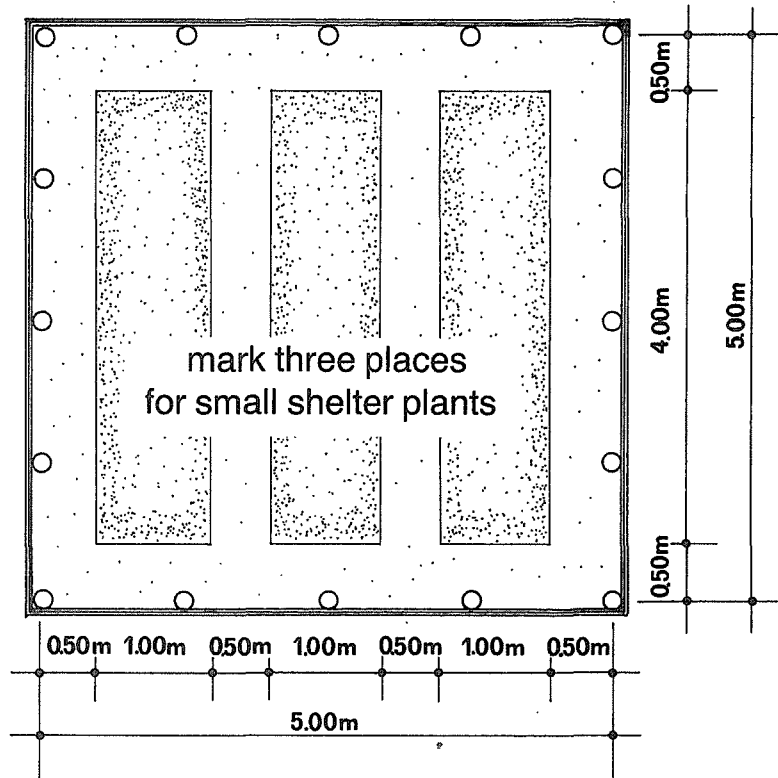

- 2 plant the shelter plants first
and then plant the food plants
all around the shelter plants

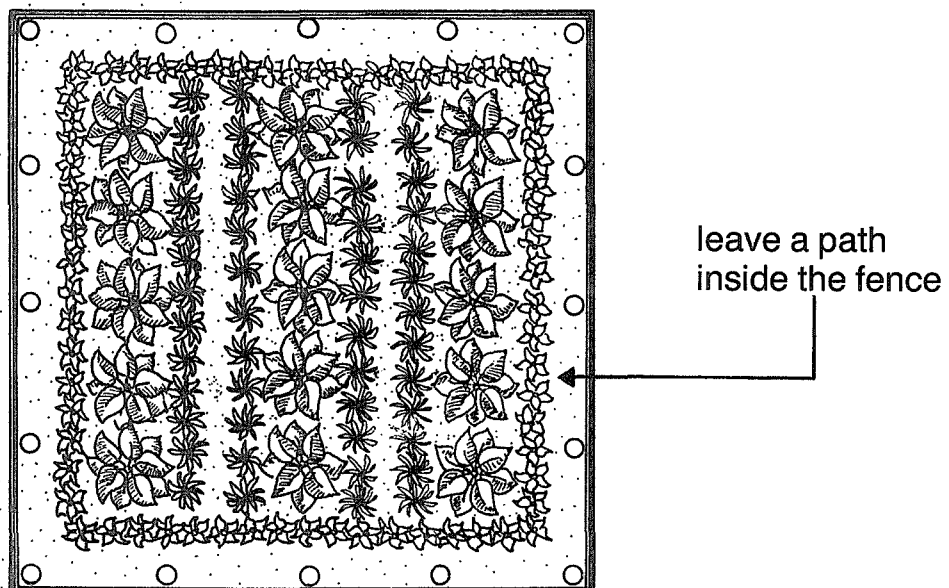

3 if your shelter plants are large,
plant your pen like this

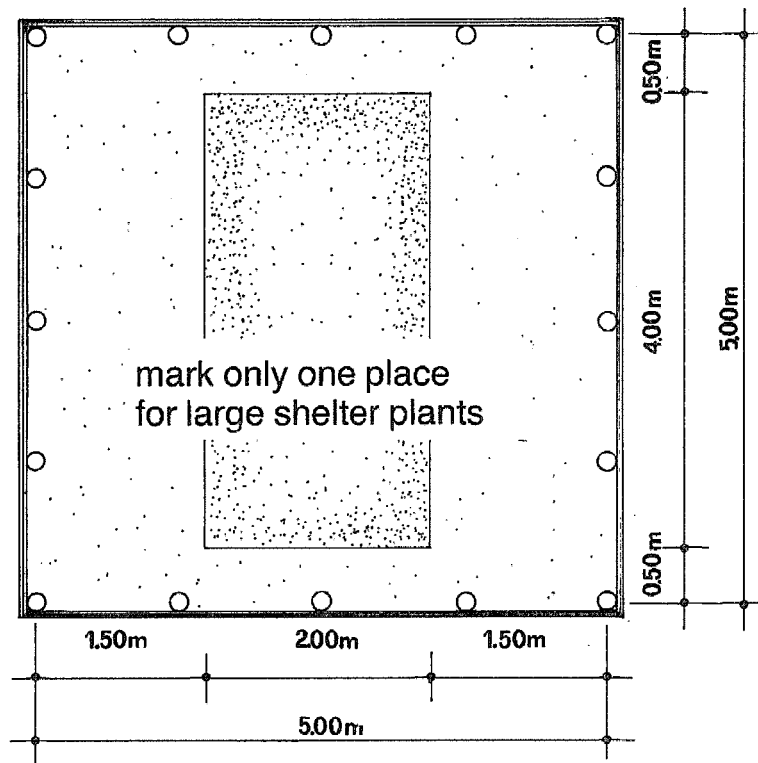

4 plant the shelter plants first
and then plant the food plants
all around the shelter plants

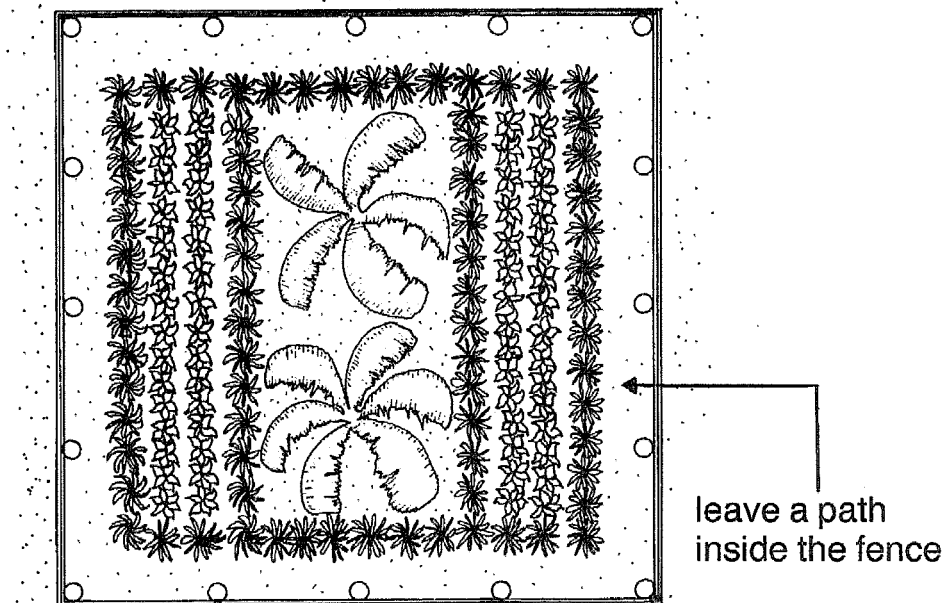

Some plants for food

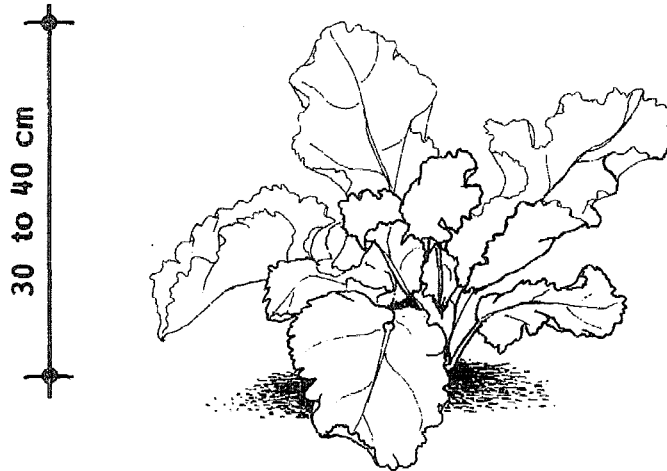

RAPE

Rape is one of many kinds of smooth-leaved cabbage. It grows from seed and lasts a number of months. Rape is the best food plant for *Helix* snails (see pages 8 and 9 in this booklet). Many of the other kinds of smooth-leaved cabbage also make good food plants for snails.



AFRICAN SPINACH (*Amaranthus*)

This green leafy vegetable is a good food plant for young *Achatina* and *Archachatina* snails (see pages 10 and 11 in this booklet). However, if you plant African spinach for your snails, they will need other kinds of food plants as well.

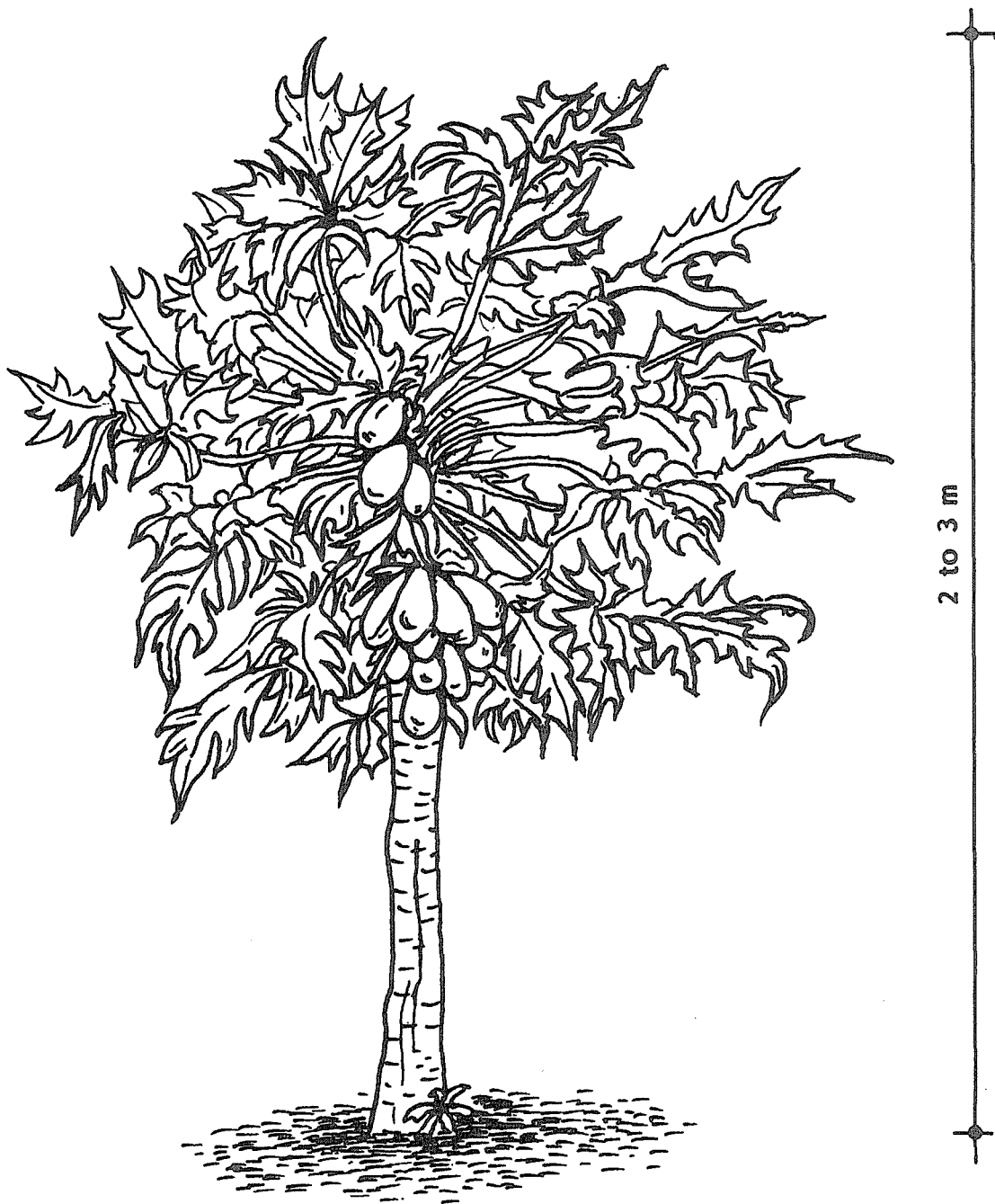

PAPAYA

You have already been told that snails can be given food to eat other than the food plants that you have planted in the pen (see also Items 175 to 179 in the next booklet). The tender green leaves and cut-up fruit of the papaya tree are very good for *Achatina* and *Archachatina* snails. However, the papaya should not be planted inside the pen.

Some plants for food and shelter

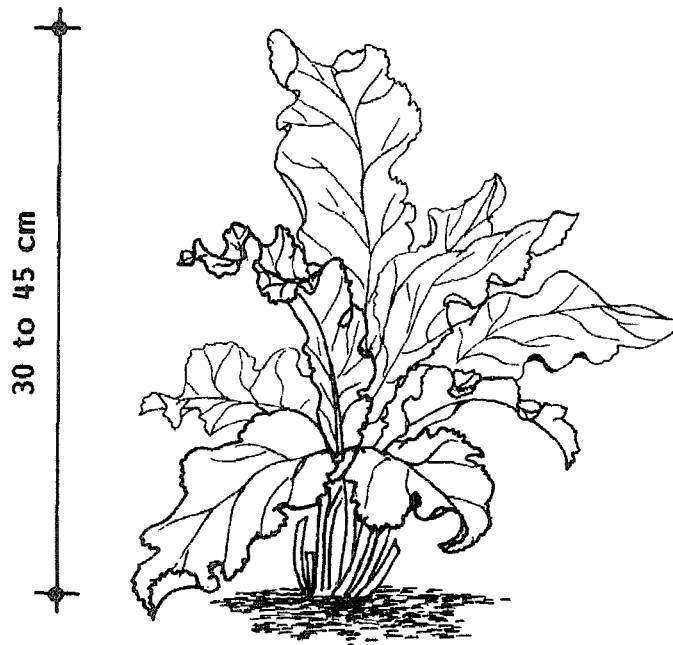

HORSE-RADISH

Horse-radish is a good food and shelter plant for young *Helix* snails. However, when they are older they will need other kinds of food plants as well.

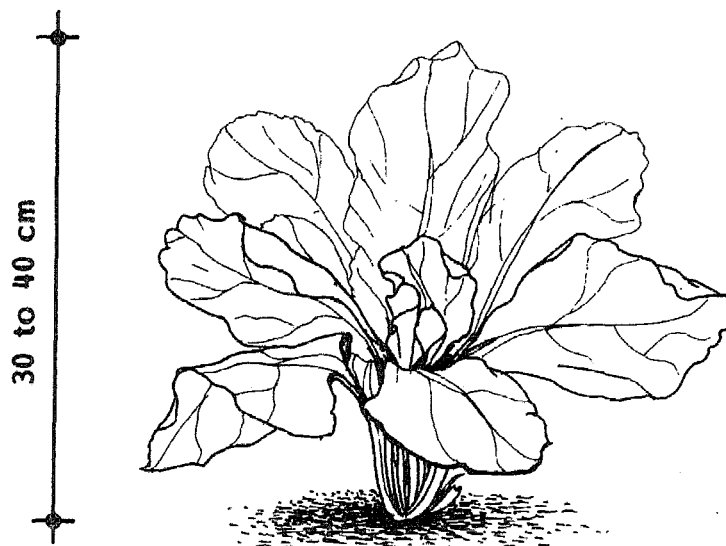

LEAF BEET

Leaf beet grows well from seed and lives for one year. It can be used with *Helix* snails for both food and for shelter. As a food plant alone it is not the best and you will have to give your snails other food plants as well. However, as a shelter plant it is very good for *Helix* snails. These snails lay eggs under the beet plants and find shelter around the roots in cold weather.



BURDOCK

Burdock grows from seed and lives for more than a year. It grows very slowly and you should plant it as soon as you can so that it can grow big enough for your snails. However, once it has grown it makes a good food and shelter plant for almost any kind of snail.

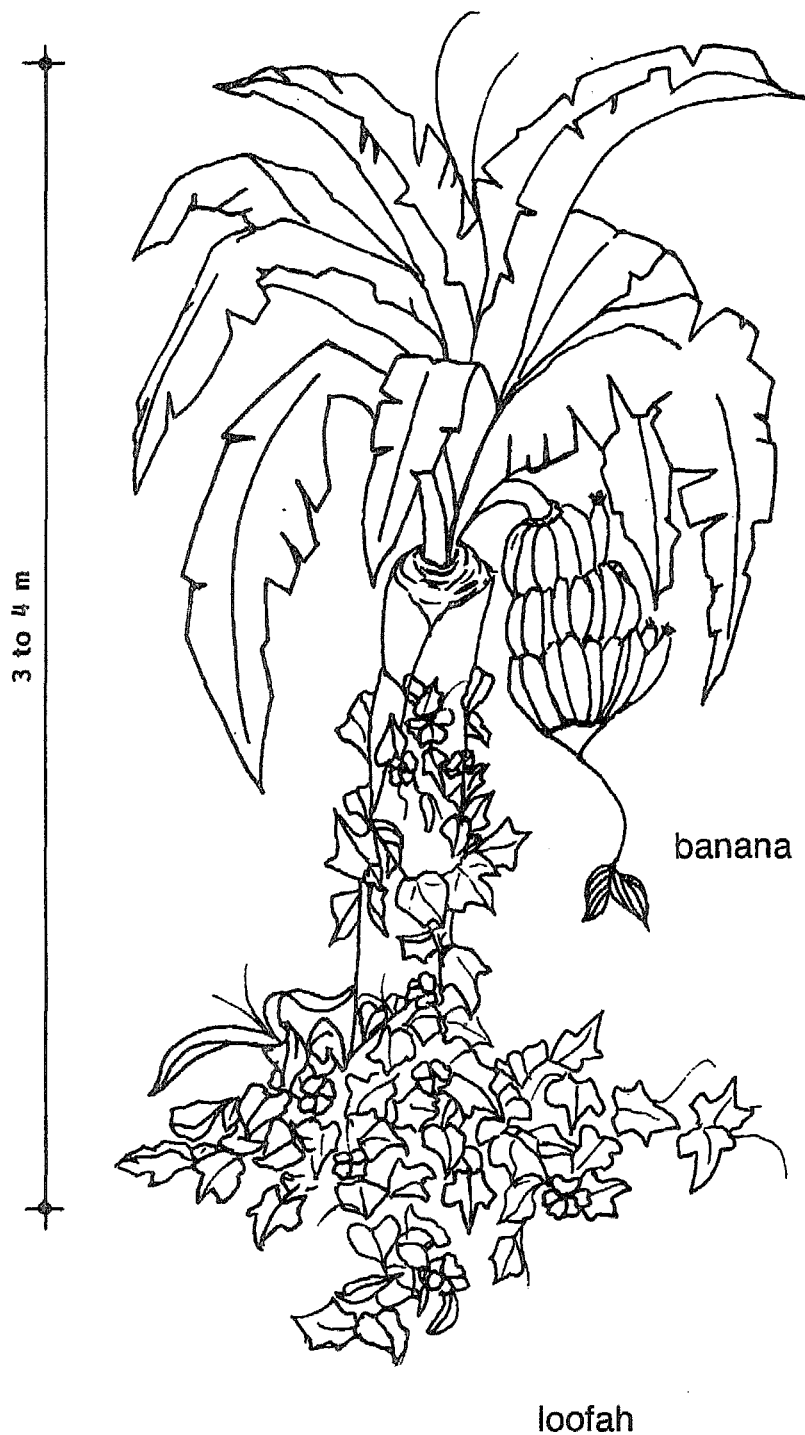

BANANA and LOOFAH

Banana and loofah plants together provide both food and shelter for *Achatina* and *Archachatina* snails. Ripe bananas can be cut up and fed to the snails and they can use the loofah plant for food and for shelter. However, your snails will need other food plants as well.

Some plants for shelter



20 to 25 cm

PLANTAGO

Plantago grows well from seed and lasts about two years. It is the best shelter plant for *Helix* snails.

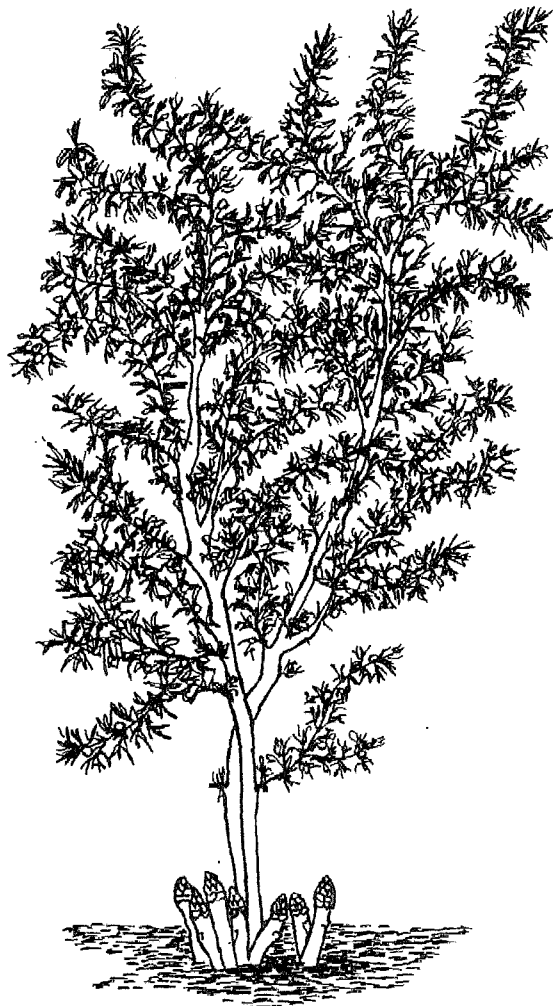

80 to 120 cm

ASPARAGUS

Asparagus lives for many years and it is a good shelter plant for young *Achatina* and *Archachatina* snails. However, it is not good for older snails because they are too heavy for asparagus plants.

**When are the plants big enough
for food and for shelter?**

118. The food plants must be big enough to feed your snails and the shelter plants tall enough to cover them and to protect them from the sun.
119. Depending on the kind of snails that you are raising, most plants will be big enough after they have been growing for about five to six weeks or when they have reached a height of 10 to 20 centimetres.



120. When you are sure that the plants are big enough to provide food and shelter, you can begin to collect the snails and put them into the pen.

121. In Booklet No. 34,
Farming snails 2,
you will learn

- how to choose good snails
and how to put them in the pen
- how to take care of your snails
- when and how to harvest snails
- how to prepare snails for cooking

122. You will also be told
some things that you can do
to improve your snail farm
so that later
when you have more experience
you can raise more and better snails.

WHERE TO PURCHASE FAO PUBLICATIONS LOCALLY

Algeria	Société nationale d'édition et de diffusion, 92, rue Didouche Mourad, Alger.
Argentina	Librería Agropecuaria S.A., Pasteur 743, 1028 Buenos Aires.
Australia	Hunter Publications, 58A Gipps Street, Collingwood, Vic. 3066; Australian Government Publishing Service, Sales and Distribution Branch, Wentworth Ave, Kingston. A.C.T. 2604. Bookshops in Adelaide, Melbourne, Brisbane, Canberra, Perth, Hobart and Sydney.
Austria	Gerold & Co., Graben 31, 1011 Vienna.
Bahrain	United Schools International, PO Box 726, Manama.
Bangladesh	Association of Development Agencies in Bangladesh, House No. 46A, Road No. 6A, Dhanmondi R/A, Dhaka.
Belgium	M. J. De Lannoy, 202, avenue du Roi, 1060 Bruxelles. CCP 000-0808993-13.
Bolivia	Los Amigos del Libro, Perú 3712, Casilla 450, Cochabamba; Mercado 1315, La Paz.
Botswana	Botswana Books (Pty) Ltd, PO Box 1532, Gaborone.
Brazil	Fundação Getulio Vargas, Praia de Botafogo 190, C.P. 9052, Rio de Janeiro; Livreria Ganuto Ltda, Rua Consolação, 348 - 2º andar, Caixa Postal 19198, São Paulo.
Brunei Darussalam	SST Trading Sdn. Bhd., Bangunan Tekno No. 385, Jln 5/59, PO Box 227, Petaling Jaya, Selangor.
Canada	Renouf Publishing Company Ltd, 61 Sparks Street, PO Box 1008, Station B, Ottawa, Ont. K1P 5R1; Tel.: (613) 238 8985. Toll-free calls in Canada: 1-800-267-4164; Telex: 053-4936.
Chile	Librería - Oficina Regional FAO, Avda. Santa María 6700, Casilla 10095, Santiago. Teléfono: 228-80-56.
China	China National Publications Import Corporation, PO Box 88, Beijing.
Congo	Office national des librairies populaires, B.P. 577, Brazzaville.
Costa Rica	Librería, Imprenta y Litografía Luhmann S.A., Apartado 10011, San José.
Cuba	Ediciones Cubanas, Empresa de Comercio Exterior de Publicaciones, Obispo 461, Apartado 605, La Habana.
Cyprus	MAM, PO Box 1722, Nicosia.
Czechoslovakia	ARTIA, Ve Smečkach 30, PO Box 790, 111 27 Prague 1.
Denmark	Munksgaard Export and Subscription Service, 35 Nørre Søgade, DK 1370 Copenhagen K.
Dominican Rep.	Fundación Dominicana de Desarrollo, Casa de las Gargolas, Mercedes 4, Apartado 857, Zona Postal 1, Santo Domingo.
Ecuador	Su Librería Cla. Ltda., García Moreno 1172 y Mejía, Apartado 2556, Quito.
El Salvador	Librería Cultural Salvadoreña, S.A. de C.V., 7ª Avenida Norte 121, Apartado Postal 2296, San Salvador.
Finland	Akateeminen Kirjakauppa, 1 Keskuskatu, PO Box 128, 00101 Helsinki 10.
France	Éditions A. Pedone, 13, rue Soufflot, 75005 Paris.
Germany, F.R.	Alexander Horn Internationale Buchhandlung, Friederichstr. 39, Postfach 3340, 6200 Wiesbaden.
Ghana	Fides Enterprises, PO Box 14129, Accra; Ghana Publishing Corporation, PO Box 3632, Accra.
Greece	G.C. Eleftheroudakis S.A., 4 Nikis Street, Athens (T-126); John Mihalopoulos & Son S.A., 75 Hermou Street, PO Box 73, Thessaloniki.
Guatemala	Distribuciones Culturales y Técnicas «Artemis», 5ª Avenida 12-11, Zona 1, Apartado Postal 2923, Guatemala.
Guinea-Bissau	Conselho Nacional da Cultura, Avenida da Unidade Africana, C.P. 294, Bissau.
Guyana	Guyana National Trading Corporation Ltd, 45-47 Water Street, PO Box 308, Georgetown.
Haiti	Librairie "A la Caravelle", 26, rue Bonne Foi, B.P. 111, Port-au-Prince.
Hong Kong	Swindon Book Co., 13-15 Lock Road, Kowloon.
Hungary	Kultura, PO Box 149, 1389 Budapest 62.
Iceland	Snaebjörn Jónsson and Co. h.f., Hafnarstraeti 9, PO Box 1131, 101 Reykjavik.
India	Oxford Book and Stationery Co., Scindia House, New Delhi 100 001; 17 Park Street, Calcutta 700 016; Oxford Subscription Agency, Institute for Development Education, 1 Anasuya Ave, Kilpauk, Madras 600 010.
Indonesia	P.T. Inti Buku Agung, 13 Kwitang, Jakarta.
Iraq	National House for Publishing, Distributing and Advertising, Jamhuriq Street, Baghdad.
Ireland	The Controller, Stationery Office, Dublin 4.
Italy	Distribution and Sales Section, FAO, Via delle Terme di Caracalla, 00100 Rome; Libreria Scientifica Dott. Lucio de Biasio "Aeiou", Via Meravigli 16, 20123 Milan; Libreria Commissionaria Sansoni S.p.A. "Licosa", Via Lamarmora 45, C.P. 552, 50121 Florence.
Japan	Maruzen Company Ltd, PO Box 5050, Tokyo International 100-31.
Kenya	Text Book Centre Ltd, Kijabe Street, PO Box 47540, Nairobi.

WHERE TO PURCHASE FAO PUBLICATIONS LOCALLY

Korea, Rep. of	Eulyoo Publishing Co. Ltd, 46-1 Susong-Dong, Jongro-Gu, PO Box 362, Kwangwha-Mun, Seoul 110.
Kuwait	The Kuwait Bookshops Co. Ltd, PO Box 2942, Safat.
Luxembourg	M. J. De Lannoy, 202, avenue du Roi, 1060 Bruxelles (Belgique).
Malaysia	SST Trading Sdn. Bhd., Bangunan Tekno No. 385, Jin 5/59, PO Box 227, Petaling Jaya, Selangor.
Mauritius	Nalanda Company Limited, 30 Bourbon Street, Port-Louis.
Mexico	Dilitsa S.A., Puebla 162-D, Apartado 24-448, México 06700, D.F.
Morocco	Librairie "Aux Belles Images", 281, avenue Mohammed V, Rabat.
Netherlands	Keesing Publishing Company B.V., Hogehilweg 13, 1101 CB Amsterdam; Post Box 1118, 1000 BC Amsterdam.
New Zealand	Government Printing Office, Government Printing Office Bookshops: 25 Rutland Street; Mail orders: 85 Beach Road, Private Bag, CPO, Auckland; Ward Street, Hamilton; Mulgrave Street (Head Office), Cubacade World Trade Centre, Wellington; 159 Hereford Street, Christchurch; Princes Street, Dunedin.
Nicaragua	Librería Universitaria, Universidad Centroamericana, Apartado 69, Managua.
Nigeria	University Bookshop (Nigeria) Limited, University of Ibadan, Ibadan.
Norway	Johan Grundt Tanum Bokhandel, Karl Johanagete 41-43, PO Box 1177, Sentrum, Oslo 1.
Pakistan	Mirza Book Agency, 65 Shahrah-e-Quaid-e-Azam, PO Box 729, Lahore 3; Sasi Book Store, Zaibunissa Street, Karachi.
Panama	Distribuidora Lewis S.A., Edificio Dorasol, Calle 25 y Avenida Balboa, Apartado 1634, Panamá 1.
Paraguay	Agencia de Librerías Nizza S.A., Casilla 2596, Eligio Ayala 1073, Asunción
Peru	Librería Distribuidora «Santa Rosa», Jirón Apurímac 375, Casilla 4937, Lima 1.
Philippines	The Modern Book Company Inc., PO Box 632, Manila.
Poland	Ars Polona, Krakowskie Przedmiescie 7, 00-068 Warsaw.
Portugal	Livraria Bertrand, S.A.R.L., Rua João de Deus, Venda Nova, Apartado 37, 2701 Amadora Codex; Livraria Portugal, Dias y Andrade Ltda., Rua do Carmo 70-74, Apartado 2681, 1117 Lisbonne Codex.
Romania	Ilexim, Str. 13 Decembrie No. 3-5, Bucharest Sector 1.
Saudi Arabia	The Modern Commercial University Bookshop, PO Box 394, Riyadh.
Singapore	MPH Distributors (S) Pte. Ltd, 71/77 Stamford Road, Singapore 6; Select Books Pte. Ltd, 215 Tanglin Shopping Centre, 19 Tanglin Road, Singapore 1024; SST Trading Sdn. Bhd., Bangunan Tekno No. 385, Jin 5/59, PO Box 227, Petaling Jaya, Selangor.
Somalia	"Samater's", PO Box 936, Mogadishu.
Spain	Mundi-Prensa Libros S.A., Castelló 37, 28001 Madrid; Librería Agrícola, Fernando VI 2, 28004 Madrid.
Sri Lanka	M.D. Gunasena & Co. Ltd, 217 Olcott Mawatha, PO Box 246, Colombo 11.
Sudan	University Bookshop, University of Khartoum, PO Box 321, Khartoum.
Suriname	VACO n.v. in Suriname, Domineestraat 26, PO Box 1841, Paramaribo.
Sweden	Books and documents: C.E. Fritzes Kungl. Hovbokhandel, Regeringsgatan 12, PO Box 16356, 103 27 Stockholm. Subscriptions: Vennergren-Williams AB, PO Box 30004, 104 25 Stockholm.
Switzerland	Librairie Payot S.A., Lausanne and Geneva; Buchhandlung und Antiquariat Heinemann & Co., Kirchgasse 17, 8001 Zurich.
Tanzania	Dar-es-Salaam Bookshop, PO Box 9030, Dar-es-Salaam; Bookshop, University of Dar-es-Salaam, PO Box 893, Morogoro.
Thailand	Suksapan Panit, Manston 9, Rajadamnern Avenue, Bangkok.
Togo	Librairie du Bon Pasteur, B.P. 1164, Lomé.
Tunisia	Société tunisienne de diffusion, 5, avenue de Carthage, Tunis.
Turkey	Kultur Yayinlari Is-Turk Ltd Sti., Ataturk Bulvari No. 191, Kat. 21, Ankara. Bookshops in Istanbul and Izmir.
United Kingdom	Her Majesty's Stationery Office, 49 High Holborn, London WC1V 6HB (callers only); HMSO Publications Centre, Agency Section, 51 Nine Elms Lane, London SW8 5DR (trade and London area mail orders); 13a Castle Street, Edinburgh EH2 3AR; 80 Chichester Street, Belfast BT1 4JY; Brazennose Street, Manchester M60 8AS; 258 Broad Street, Birmingham B1 2HE; Southey House, Wine Street, Bristol BS1 2BQ.
United States of America	UNIPUB, PO Box 1222, Ann Arbor, MI 48106.
Uruguay	Librería Agropecuaria S.R.L., Alzaibar 1328, c.c. 1755, Montevideo.
Yugoslavia	Jugoslovenska Knjiga, Trg. Republike 5/8, PO Box 36, 11001 Belgrade; Cankarjeva Založba, PO Box 201-IV, 61001 Ljubljana.
Zambia	Kingstons (Zambia) Ltd, Kingstons Building, President Avenue, PO Box 139, Ndola.
Other countries	Requests from countries where sales agents have not yet been appointed may be sent to: Distribution and Sales Section, FAO, Via delle Terme di Caracalla, 00100 Rome, Italy.